

**Équipements textiles opérationnels**

# DIMATEX

Fiers de vous servir



# SOMMAIRE













- 1 - Opérationnel
- 2 - Médical Opérationnel
- 3 - Extraction
- 4 - Paquetage
- 5 - Développement / Services / SAV
- 6 - Équipements de Secours: SMU et incendie
- 7 - Black Line

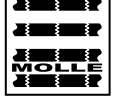

## Qui sommes-nous ?

Spécialiste des tissus techniques, DIMATEX Sécurité conçoit, produit et commercialise des équipements textiles destinés exclusivement aux professionnels de l'action.



	Compatible avec un sac MOLLE	Compatible avec le port d'une veste balistique	
	Protection anti-choc	Accès fond de sac	
	Equipé du système MOLLE (MOdular Lightweight Load-carrying Equipment)	Imperméable	
	Anneau de treuillage intégré	Couvre-sac intégré Couvre-bretelles intégré	
	Indication de poids	Abri	
	Système d'extraction facile UP SAFE	Sac roulant	

Photos non contractuelles



**1.**

# OPÉRATIONNEL

- TALWEG: sac combat 3 jours
- NIJRAB: brelage d'allègement
- RIPOSTE: porte grenade à fusil
- KAPISA: poche polyvalente
- SANDART: poche polyvalente
- TAGAB: trousse individuelle du combattant
- NIMITZ: plateforme auto-agrippant
- SHERPA: claie de portage
- SUROBI: gants tactiques non-feu
- DRAKKEN: harnais pour chien
- REMPART: veste balistique d'entraînement
- Produits divers

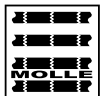

# TALWEG

## Sac de combat 3 jours



Portage spécialement conçu pour être compatible avec l'utilisation d'une veste balistique



### Couleurs:



CENTRE EUROPE



NOIR



VERT OLIVE (vert OTAN)



COYOTE

Intérieur MOLLE + velcro + sangles

Poches filets



Anneau d'hélicreusement intégré et protégé

### Caractéristiques techniques:

- Tissu polyamide 1680 deniers, imperméable, haute résistance
- Portage à dos optimisé pour le port d'une veste balistique
- Fermeture à glissière YKK jauge 12
- Anneau de treillage et d'hélicreusement intégré, protégé et identifié
- MOLLE en face avant, sur les côtés et sur le dessous
- Possibilité de glisser une plaque balistique dans le dos du sac
- Porte-étiquette extérieure
- Sortie pour poche à eau
- Double sortie pour antenne radio
- Oeillet d'évacuation d'eau du compartiment principal et des poches frontales
- Sangles de compression
- Accès fond de sac
- 4 anneaux d'arrimage (véhicule, aéronef...)
- MOLLE sur la face intérieure + velcro
- Anti-choc: poches frontales et fond de sac anti-choc
- Compatible avec la ceinture NIJRAB

### Dimensions:

- Largeur: 35 cm
- Hauteur: 47 cm
- Profondeur: 19 cm

### Volumes:

35 Litres

### Poids: 2,6kg

### Couleurs:

- Cam C-E (MIL1027)
- Vert OTAN (MIL1026)
- Noir (MIL1028)
- Coyote (MIL1029)

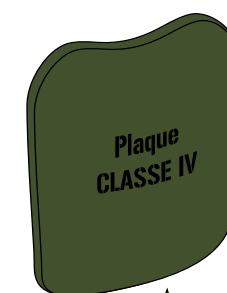

Plaque balistique

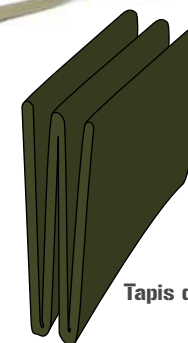

Tapis de sol

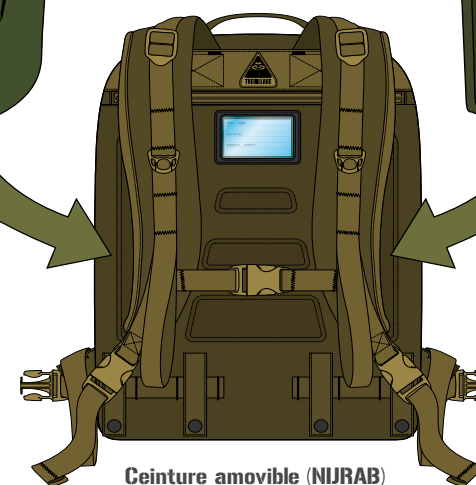

Ceinture amovible (NIJRAB)



# NIJRAB

Brelage d'allègement  
ceinture + bretelles

Couleurs:



CENTRE EUROPE NOIR VERT OLIVE (vert OTAN) COYOTE



Caractéristiques techniques:

### Ceinture:

- Tissu Pa 1680 Deniers
- Mesh anti-transpiration
- Ceinture moussée semi-rigide
- Réglages latéraux
- Passants MOLLE
- Passants pour sangle 50 mm
- Dispositif de fixation sac à dos

### Bretelles:

- Extra-plates pour être portées sous une veste balistique
- Fixation MOLLE
- Réglables
- Elastique au niveau du dos

Possibilité d'intégration d'un  
harnais anti-chute DROP



Caractéristiques techniques:

- Cam Centre-Europe (MIL1022)
- Noir (MIL1023)



Compatible  
prolongateur de  
cuisse 50mm



Compatible  
prolongateur de  
cuisse MOLLE



# NIJRAB DROP

Harnais anti-chute et maintien au travail

EN 12277  
EN 358

Caractéristiques techniques:

- 1 point d'ancrage ventral
- 2 points d'ancrages latéraux
- Boucle automatique
- Réglages latéraux

Sangle de cuisse amovible



# RIPOSTE

## Porte grenade à fusil



### Couleurs:



CENTRE  
EUROPE

NOIR

VERT OLIVE  
(vert OTAN)

COYOTE



### Capacité:

- 3 grenades de type:
- APAV40
- AC58
- LGI
- + munition jusqu'à 60mm

### Couleurs:

- Noir (MIL1033)
- Vert OTAN (MIL1025)
- Cam CE: (MIL1024)
- Coyote (MIL1064)

### Caractéristiques techniques :

- Tissu polyamide 1680 Deniers
- Demi-coque de protection thermoformée
- Auto-serrage individuel des munitions
- Serrage personnalisable
- Fixation MOLLE

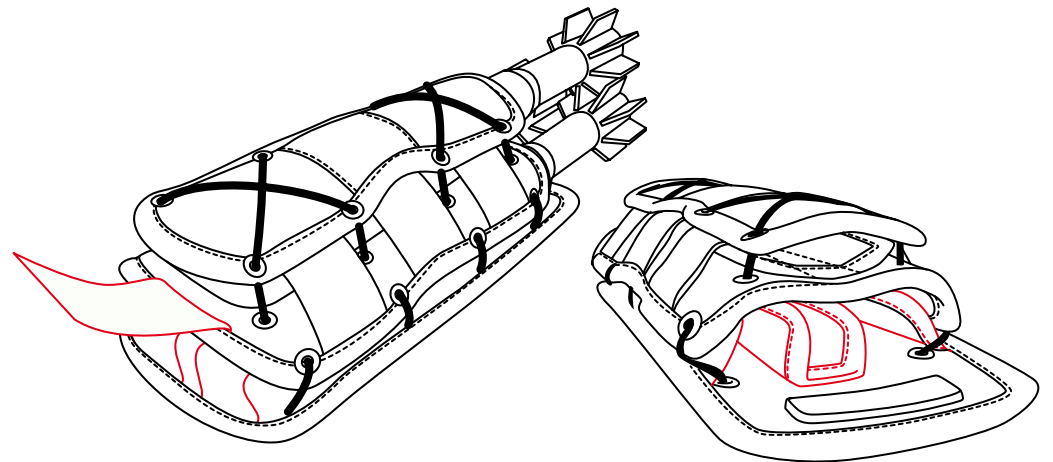

1

Régler la profondeur des grenades de manière indépendante avec les velcros situés à l'extrémité

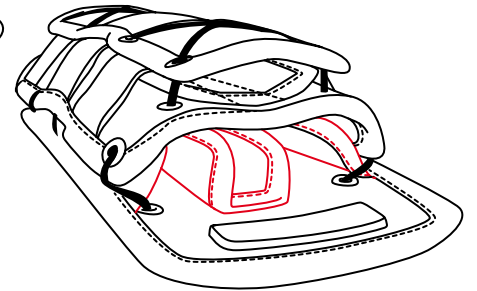

2

Lors de la première utilisation: Veillez à relever les ailettes intérieures. Elles doivent serrer la grenade de part et d'autre.

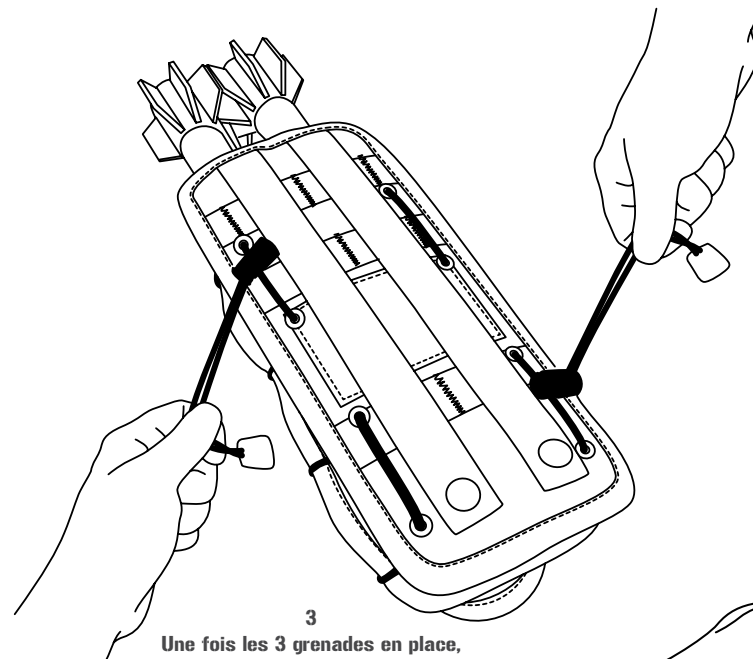

3

Une fois les 3 grenades en place, affiner le serrage en fonction du diamètre de la munition.

4

Vérifier le serrage.

Un bon serrage permet:

- de maintenir les grenades en place même à l'envers
- de sortir une grenade d'une seule main
- de maintenir la ou les grenade restantes

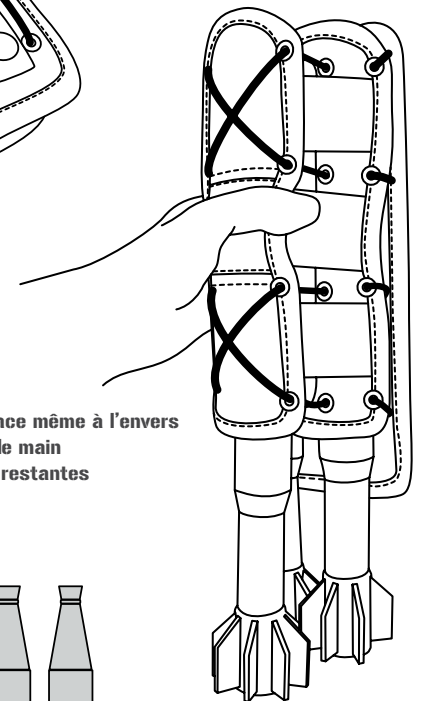

### Exemple

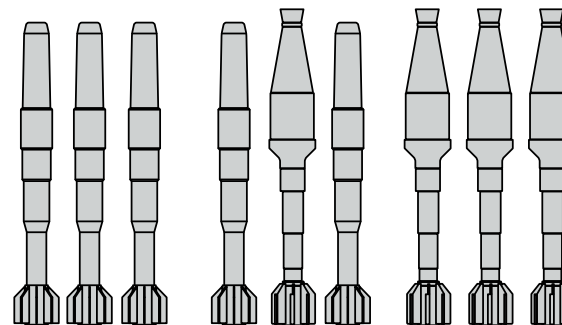

3 APAV 40  
Serrage fort

2 APAV 40 + 1 AC 58  
Serrage moyen

3 AC 58  
Serrage normal



# KAPISA

## Poche polyvalente

Dimensions: 14 x 5 x 4 cm

Poids: 80g

Couleurs:

- Coyote (MIL1093)
- Noir
- Vert OTAN



Couleurs:



Caractéristiques techniques:

- Ripstop 500 Deniers
- Fermeture velcro
- MOLLE
- Système UPSAFE
- Polyvalent: garrot, chargeur FAMAS, radio, ...

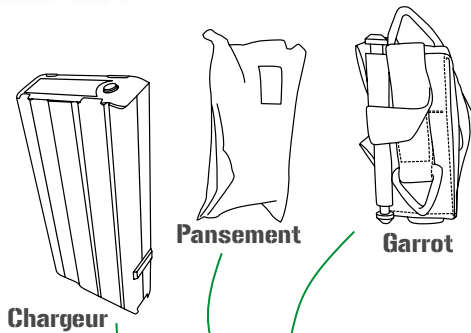

Chargeur

Pansement

Garrot

Tirer sur le cordon pour "reconditionner" la pochette

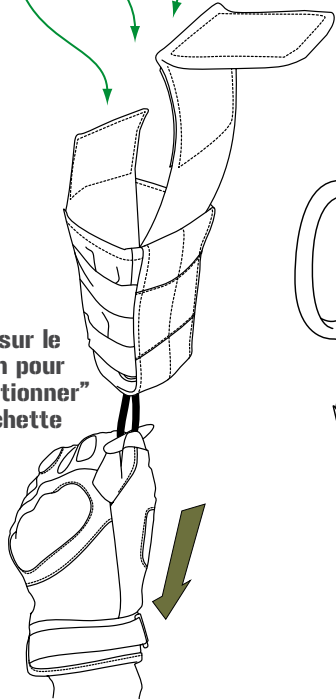

Tirer sur la sangle pour ouvrir et extraire automatiquement le contenu



# SANDART

## Poche polyvalente



Couleurs:



Dimensions pliées: 10 cm x 13 x 2 cm

Dimensions dépliées: 23 x 14 x 14 cm

Couleurs:

- Vert OTAN (MIL2006)
- Noir (MIL2007)
- Coyote (MIL2008)

Caractéristiques techniques:

- Tissu extérieur polyamide 1680 Deniers
- Tissu intérieur: Ripstop 500 Deniers
- MOLLE

# SCOUT

## Poche polyvalente

MIL1034

Dimensions:  
20 cm x 13 cm

Caractéristiques techniques:

- Tissu polyamide 1680 Deniers
- Poche téléphone & gants latex
- 2 cloisons intérieures
- Porte stylos, stylo pupille...
- MOLLE





# TAGAB

## Trousse individuelle du combattant



### Couleurs:



CENTRE EUROPE

NOIR

VERT OLIVE  
(vert OTAN)

COYOTE

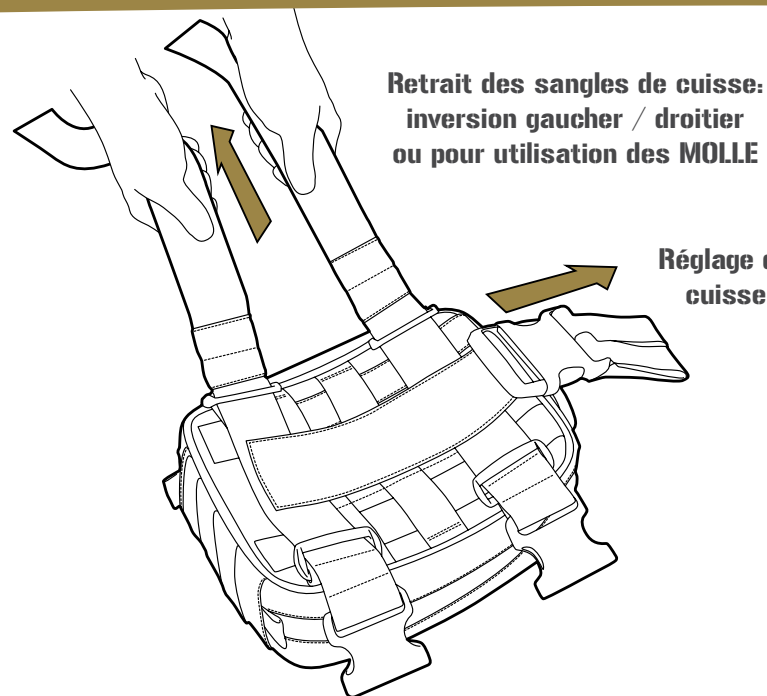

Retrait des sangles de cuisse:  
inversion gaucher / droitier  
ou pour utilisation des MOLLE

Réglage de la hauteur  
cuisse / ceinture

### Couleurs:

- Cam CE (MIL1017)
- Noir (MIL1018)
- Vert OTAN (MIL1019)
- Coyote (MIL1016)

### Dimensions:

- Largeur: 16 cm
- Hauteur: 20 cm
- Profondeur: 8 cm

### Caractéristiques techniques:

- Tissu haute-résistance 1680 D Polyamide
- Zipper YKK taille 12
- Fixation MOLLE sur la face avant
- Intercalaire double face amovible
- Fixation cuisse, ceinture ou veste balistique

### Dispositif de fixation cuisse amovible:

- Inversion des sangles de cuisse: gaucher / droitier
- Réglage de la hauteur de cuisse / ceinture
- Retrait des sangles pour fixer la poche sur un sac ou sur une veste balistique (MOLLE)



Intercalaire intérieur  
amovible



# NIMITZ

## Plateforme auto-agrippante universelle



### Caractéristiques techniques:

- Plateforme MOLLE / velcro
- Fixation sangle de cuisse et ceinture
- Fixation MOLLE sur la face arrière
- Sangle de sécurisation
- Fixation cuisse, ceinture ou veste balistique

### Configuration cuisse (kit de cuisse):

- Inversion des sangles de cuisse: gaucher / droitier
- Réglage de la hauteur de cuisse / ceinture
- Retrait des sangles pour fixer la poche sur un sac ou sur une veste balistique (MOLLE)

### Couleurs:

- Vert OTAN (MIL2003)
- Noir (MIL2004)
- Coyote (MIL2005)

### Dimensions:

- Largeur: 15 cm
- Hauteur: 20 cm

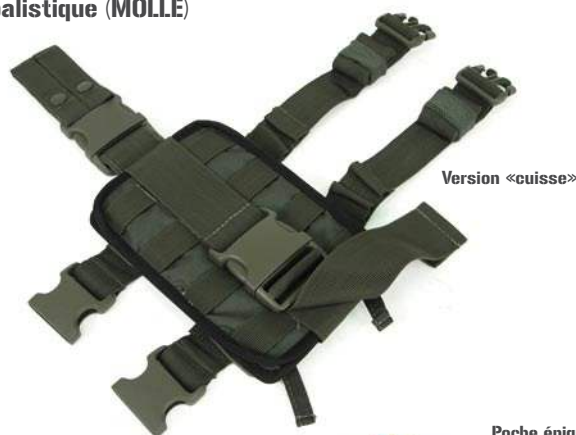

# ACCESSOIRES



## Kit de cuisse compatible TAGAB, BAGRAM, NIMITZ:

prolongateur + 2 sangles

- Couleurs:
- Vert OTAN (MIL1060)
  - Noir (MIL1061)
  - Coyote (MIL1062)



## Sangle de compression

25 x 800 mm

- Couleurs:
- Vert OTAN (MIL1052)
  - Noire (MIL1053)
  - Coyote (MIL1054)

## Prolongateur de cuisse

- Couleurs:
- Vert OTAN (MIL1055)
  - Noir (MIL1056)
  - Coyote (MIL1057)

## WEB DOMINATOR

(coyote MIL1050)



## TACTICAL LINK

(coyote MIL1048)



## GRIM LOCK

(coyote MIL1049)



## ICE LOCK

(noir MIL1051)



# SHERPA

## Claie de portage polyvalante



Couleurs:



Harnais réglable  
5 tailles



version standard



version standard

### Dimensions:

Largeur: 35 cm  
Hauteur: 83 cm.  
Prof. plateau: 26 cm  
Prof. totale: 40 cm

### Poids:

3 kg

### Couleurs:

-Noir (version standard: MIL1014)  
-Cam. CE (version standard MIL1010)

### Version standard

#### Caractéristiques techniques:

- Structure en alliage d'aluminium
- Partie textile en Polyamide 1680 deniers imperméable
- Portage entièrement démontable pour le lavage
  - Réglable en 5 tailles
  - Bretelles ergonomiques doublées mesh
  - Dos ventilé avec appuis lombaires
  - Rappel de charge
  - Bloqueur de poitrine
  - Mousse haute densité spécial charges lourdes
  - Large ceinture abdominale à dégagement rapide
- Poignée de chargement en rubber
- Patin anti-usure
- Clip de fixation pour pose d'un camelback (en option)
- Coffre 35x19,5x29cm



version MILAN:  
poste de tir

### Version pour système d'arme MILAN

Claie missile: 2 missiles MILAN + 1 MIRA

Claie poste de tir: 1 poste de tir MILAN

#### Caractéristiques spécifiques:

- Rapidité de mise en oeuvre
- Répartition symétrique de la charge
- Portage ergonomique: réglage 5 tailles
- Structure rigide en aluminium
- Coffre pour accessoires + MOLLE
- Main-libre (utilisation de son arme)



version MILAN:  
missiles

Accès supérieur du  
coffre total



Calage du  
poste de tir



SHERPA OPS  
Cam CE: MIL1078  
Noir: MIL1079



SHERPA MILAN poste de tir  
Cam CE: MIL1074  
Noir: MIL1075



SHERPA MILAN Missiles  
Cam CE: MIL1076  
Noir: MIL1077

Structure modifiable à la demande



# SUROBI

Gants tactiques non-feu

NOMEX

Couleurs:



NOIR COYOTE

## Caractéristiques techniques:

- Tissu 100% ARAMIDE
- Cuir ignifuge et hydrophobe
- Dextérité accrue de l'index pour le tir
- Coque de protection en composite
- Sangle de serrage du poignet
- Protection des phalanges contre les chocs
- Renfort de la paume
- Renfort spécial tireur
- Système de maintien des gants en attente (en option)



Protection hypalon du dessus de la main



Serrage de la largeur de main



Protection hypalon du coté de la main



# DRAKKEN

Harnais pour chien de recherche et de sauvetage

Couleurs:



Couleurs:

Cam CE, Noir, Vert OTAN, Coyote, Bleu et Rouge

Taille unique:

-tour de cou: de 43 à 65cm  
-tour de buste: de 55 à 110cm



Caractéristiques techniques :

- Tissu polyamide 1680 deniers
- Doublure respirante
- 4 points de serrage
- Poignée moulée amovible
- Fixation pour flasher, lampe ou cyalume
- Anneau de sangle pour la fixation de la laisse
- Patch France sur velcro (fourni)
- Support velcro pour patronyme
- Support velcro pour Unité
- Bande rétro-réfléchissante (uniquement sur la version rouge et bleu)

Poignée amovible



Anneau de sangle pour la laisse



# REMPART

Veste balistique  
d'entraînement aux missions opérationnelles



Couleur:



COYOTE



Caractéristiques techniques:

- Poids réel (plaques aluminium)
- Encombrement réel
- Organisation des équipements, avant transfert sur gilet opérationnel.

Couleur: coyote



exemples de configuration





## SENTINEL

Porte document A4



## INTER ROLL

Sac grande capacité à roulette



Dimensions:  
56 x 44 x 28 cm

Poche haute:  
37 x 17 x 7 cm  
Poche basse:  
38 x 32 x 8 cm  
Poche latérale:  
13 x 54 x 5 cm

## ACTION V

Sac d'intervention polyvalent



Dimensions: 32 x 42 x 20 cm

## BAROUD

Sac grande capacité 95 litres



Dimensions:  
56 x 65 x 34 cm



**2.**

# MÉDICAL OPÉRATIONNEL

- BAGRAM: trousse individuelle du combattant
- CHOC: trousse individuelle de secours
- BLAST: dispositif de pressurisation d'un soluté
- CAPSULE: mallette anti-choc
- STUP 15: poche anti-choc
- DECLIC: sac organisateur déroulant
- FOB SOL: sac polyvalent
- FOB AERO: sac oxygénothérapie
- TOM: panneau modulaire
- Poches accessoires

FRANCE

MEDIC

A  
+POS+

# BAGRAM

## Trousse individuelle du combattant



### Couleurs:

- Cam CE (MIL1097)
- Noir (MIL1098)
- Vert OTAN (MIL1099)
- Coyote (MIL1096)

### Poids:

- 620 g sans sangle de cuisse
- 740 g avec sangles de cuisse

### Dimensions:

- Largeur: 16 cm
- Hauteur: 20 cm
- Profondeur: 8 cm



### Caractéristiques techniques:

- Tissu ripstop 500D PES et Polyamide 1680D
- Zipper YKK taille 12
- Fixation MOLLE sur la face avant
- Intercalaire double face amovible
- 2 fourreaux de rangement en face avant
- poche frontale
- Pontet élastique sur les côtés
- Élastiques de maintien intérieurs double sens.
- Fixation cuisse, ceinture ou veste balistique



### Dispositif de fixation cuisse amovible:

- Inversion des sangles de cuisse: gaucher / droitier
- Réglage de la hauteur de cuisse / ceinture
- Retrait des sangles pour fixer la poche sur un sac ou sur une veste balistique (MOLLE)

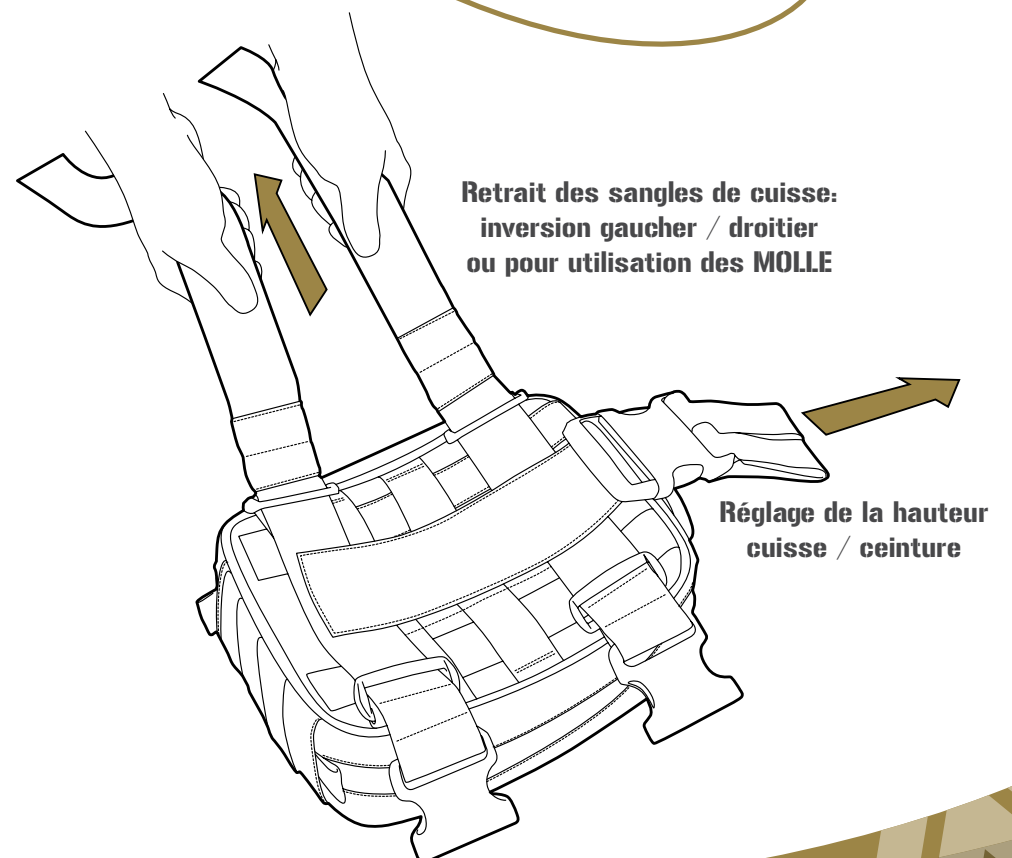
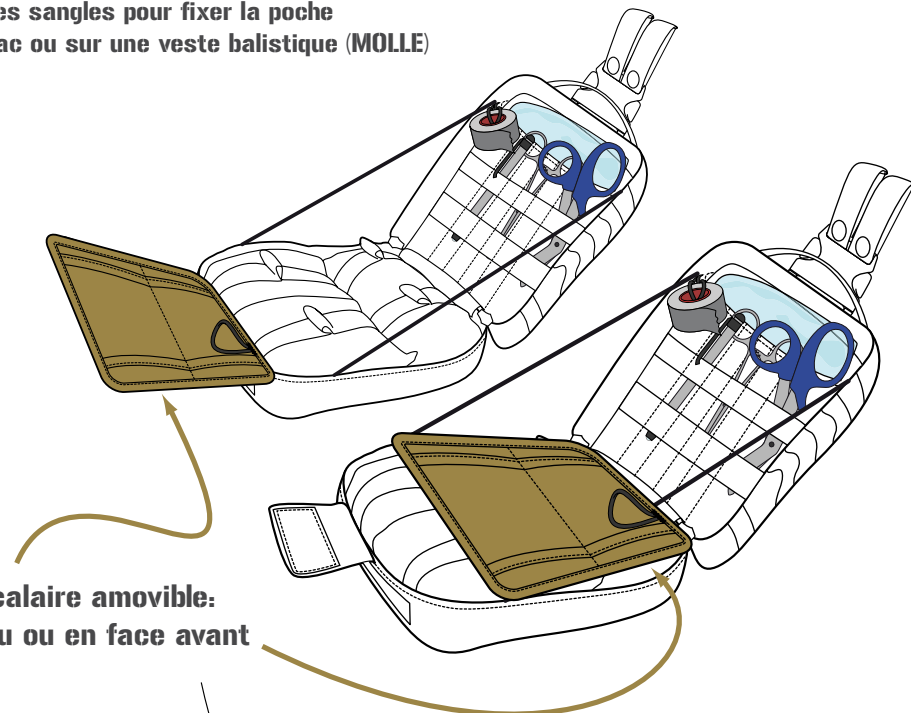



# CHOC

## Trousse individuelle de secours

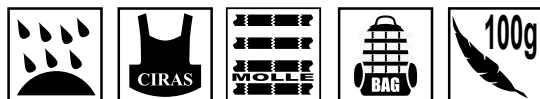

Couleurs:



Trousse « afghane »

Dimensions: 10 x 15 x 6 cm

Couleurs:

- Noir (MIL1094)
- Vert OTAN (MIL1095)

Caractéristiques techniques:

- Tissu polyester RIPSTOP
- Sangle de compression
- MOLLE



# Trousses complètes

## Nous pouvons remplir vos trousses sur demande en fonction des théâtres et des missions (composées par un pharmacien)



Exemple de configuration avec une poche BAGRAM



Exemple de configuration avec une poche TAGAB



Exemple de configuration avec une poche CHOC





# BLAST

Dispositif de pressurisation d'un soluté

**Caractéristiques techniques:**

- Tissu ripstop 600 Deniers
- Fermeture YKK taille 8
- Crochet et sangle de suspension
- Coussin de pressurisation
- Dispositif de contrôle de la pression
- Logement pour la poire de pressurisation

**Dimensions:**

Largeur: 16 cm  
Longueur: 35 cm.

**Couleur:**

-Vert OTAN

**Couleurs:**



# CAPSULE

Mallette anti-choc

**Dimensions:**

24 x 34 x 12 cm

**Couleurs:** vert OTAN, coyote, noir

**Caractéristiques techniques:**

- Coque anti-choc thermo-moulée
- Double zipper YKK taille 12
- Petite poignée de transport
- Support velcro pour identification
- MOLLE sur les deux faces
- 2 poches-filet intérieures
- 2 poches CHOC
- 1 intercalaire cristal amovible

**Couleurs:**



# STUP 15

Poche anti-choc

**Dimensions:**

20 x 8 x 4 cm

**Couleurs:** vert OTAN, coyote, noir

**Caractéristiques techniques:**

- Coque anti-choc thermo-moulée
- Double zipper YKK
- MOLLE



**Couleurs:**



Présentée ici en version ampoulier



# DECLIC

En dotation officielle

## Sac organisateur déroulant

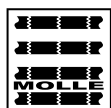

**Dimensions:**  
80 x 30 cm déplié

**Couleurs:**  
-Vert OTAN (MIL1039)  
-Coyote (MIL1041)  
-Noir (MIL1040)

### Caractéristiques techniques:

- Tissu Ripstop 500 Deniers
- Sangles de compression
- Sangles d'arrimage
- 8 points d'ancrage
- Système MOLLE
- 12 poches-filet traversantes
- 2 poches crital zippées

### Couleurs:



Cordon élastique

MOLLE

Rangement plié en 3 volets

Ou

Repli rapide en deux  
(maintien par velcro et poignée)

Points d'ancrage au sol  
(x8)

Plan de travail

«Volets» anti-poussière  
une fois replié

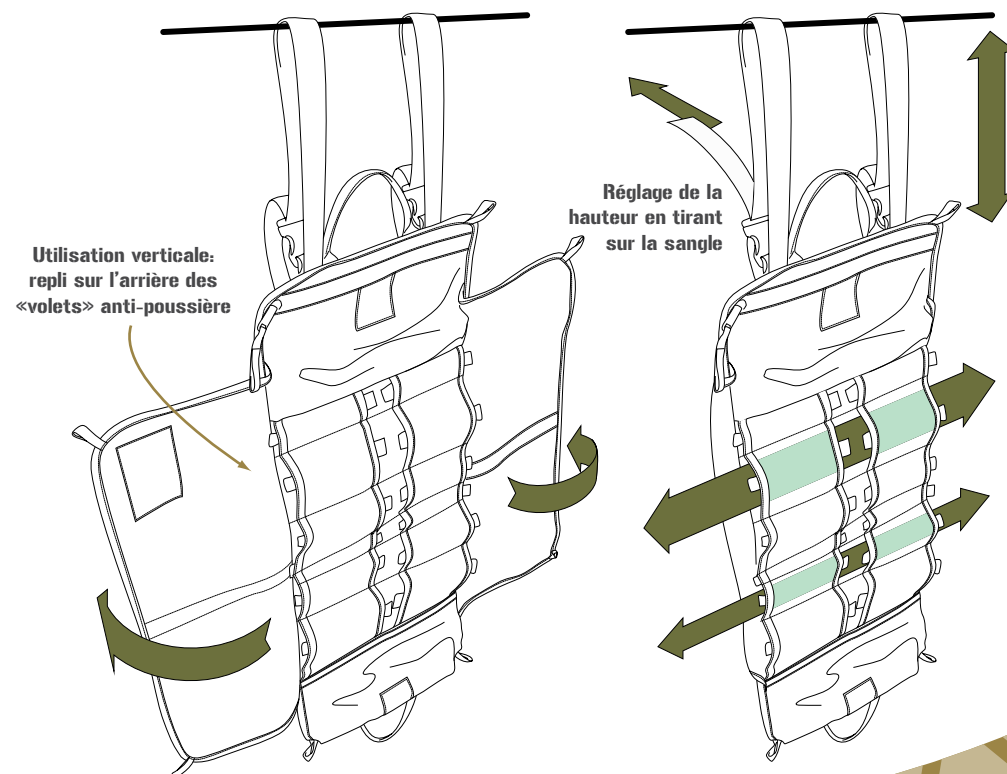

# FOB SOL

En dotation officielle

## Sac polyvalent



### Dimensions:

Largeur: 26cm  
Hauteur: 61cm  
Profondeur: 23cm

### Poids sac seul:

1,8kg

### Couleurs:

-Vert Otan (MIL1070)  
-Noir (MIL1071)  
-Coyote (MIL1073)



### Couleurs:



NOIR



VERT OLIVE  
(vert OTAN)



COYOTE

### Caractéristiques techniques:

- Tissu polyamide 1680 deniers, imperméable, haute résistance
- Portage dos compatible avec le port d'une veste balistique
- Fermeture à glissière YKK jauge 12
- Poignée de treuillage et d'hélictreuillage intégrée et identifiée
- Poignées de portage haute et latérales
- Poche frontale intégrée
- MOLLE en face avant, sur les côtés et sur le dessous
- MOLLE double sens sur les côtés
- Sortie pour poche à eau
- Sangles de compression
- Accès fond de sac bi-latéral
- 4 anneaux d'arrimage (véhicule, avion, ...)
- MOLLE sur la face intérieure + velcro
- 2 tablettes amovibles
- Ceinture amovible
- Couvre-sac réversible:
  - basse visibilité / haute visibilité



Poignée de treuillage



Tablettes amovibles

### Accessoires inclus dans le sac



1 ceinture amovible  
(pelviennne de circonstance)



4 sangles de  
compression



2 poches amovibles



Housse polyvalente



Exemple de  
configuration



Couvre-sac réversible





# FOB AERO

En dotation officielle

## Sac Oxygénothérapie

### Dimensions:

Largeur: 27cm  
Hauteur: 71cm.  
Profondeur: 22cm

### Poids sac seul:

2,40kg

### Couleurs:

-Vert Otan (MIL1066)  
-Noir (MIL1067)  
-Coyote (MIL1069)



Bretelles  
dissimulables



### Couleurs:



NOIR



VERT OLIVE  
(vert OTAN)



COYOTE



### Caractéristiques techniques:

- Tissu polyamide 1680 deniers, imperméable, haute résistance
- Portage dos compatible avec le port d'une veste balistique
- Bretelles dissimulables
- Fermeture à glissière YKK jauge 12
- Poignée de treillage et d'hélitreillage intégrée et identifiée
- Poignées de portage haute et latérales
- Accès rapide haut de sac
- MOLLE en face avant, sur les côtés et sur le dessous
- Sangles de compression
- Accès fond de sac latéraux
- 4 anneaux d'arrimage (véhicule, aéronef, ...)
- MOLLE sur la face intérieure + velcro
- 1 tablette escamotable
- Couvre-sac réversible:  
basse visibilité / haute visibilité

Poignée de treillage



Dispositif de fixation polyvalent



Trappe d'accès supérieure

### Accessoires inclus dans le sac



4 sangles de  
compression



3 poches polyvalentes



1 poche frontale amovible



Couvre-sac réversible



Bretelles  
dissimulables



# T.O.M.



## Panneau modulaire



### Dimensions:

- Replié: 45 x 45 x 18 cm
- Déplié: 100 x 45 cm

### Caractéristiques techniques:

- Tissu Pa 1680 Deniers imperméable
- Anneau de treuillage et d'héltreuillage intégré, protégé et identifié
- Zipper YKK taille 12
- Portage à main, à dos ou en bandoulière
- Sangles de compression
- MOLLE
- Système de suspension:
  - sur câble
  - sur véhicule
  - sur barre
- Anneaux d'ancrage pour aéronefs...
- Support velcro et MOLLE pour pochettes amovibles



### Couleurs:

- Vert Otan (MIL1053)
- Noir (MIL1036)
- Coyote (MIL1038)

### Couleurs:



Couvre-sac réversible



Dotation de base du sac:  
6 pochettes CRISTAL velcro + sécurisation MOLLE

Couvre-sac réversible:  
noir et fluo pour repérage

Crochet de suspension  
universel:  
porte, véhicule, barre,  
câble, mur...

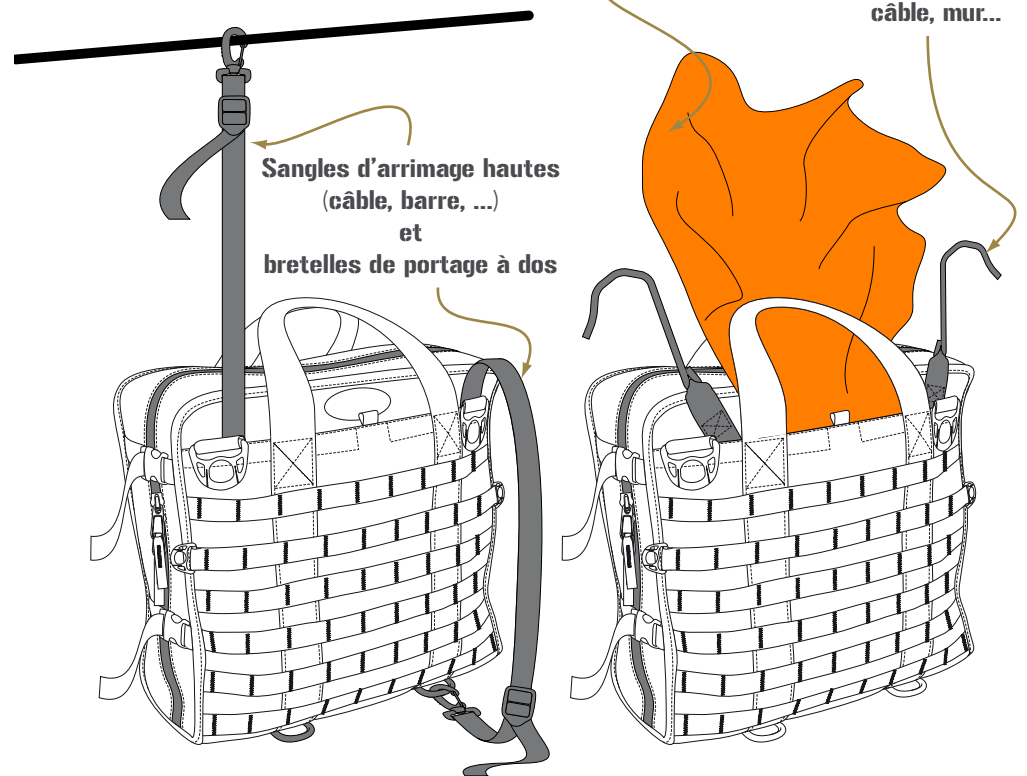

Sangles d'arrimage hautes  
(câble, barre, ...)  
et  
bretelles de portage à dos

Sangle de sécurisations  
des pochettes CRISTAL

Cloison amovible

Filet

Bandes élastiques

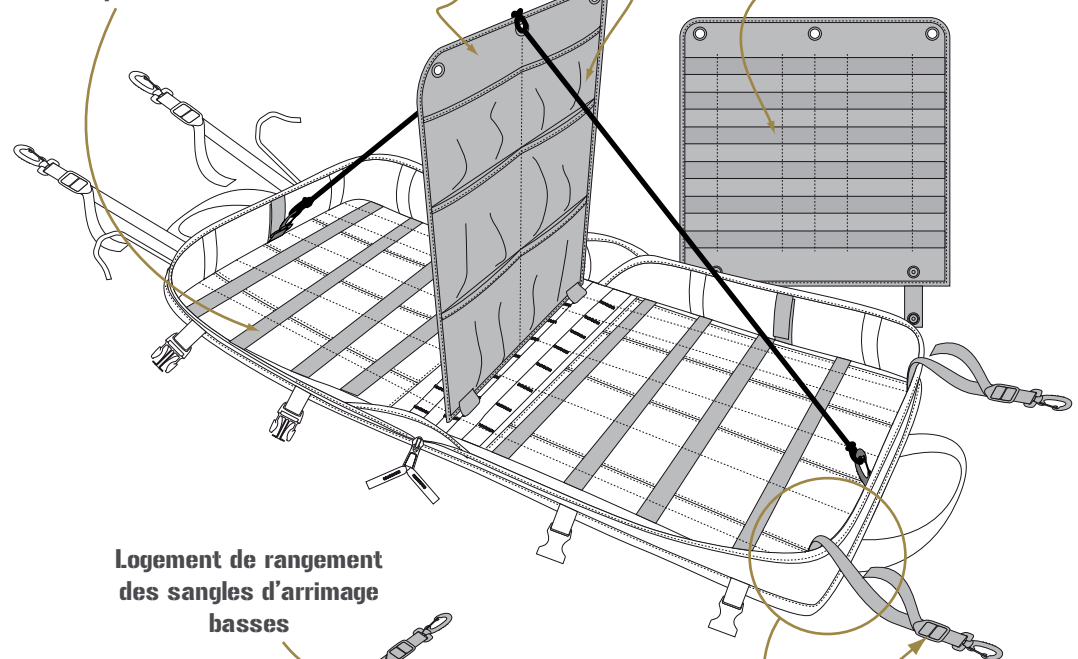

Logement de rangement  
des sangles d'arrimage  
basses

Velcro

Sangles  
d'arrimage  
basses



#### Caractéristiques techniques:

- Fermeture par zippers
- Poignée sangle
- Face-avant transparente
- Fixation velcro
- Tissu Nylon 420 D et PU
- Dimensions: 26 x 8 x 13 cm
- Couleurs: rouge, vert, bleu, jaune, noir

## POCHON

### Poche Transparente



## CRISTAL

### Poche transparente



- Oeillets pour plombage
- Poignée tissu
- Réserve pour identification
- Fixation: velcro
- Tissu Nylon 420 D et PU

Dimensions et couleurs:  
petite: 13 x 20 x 8 cm, rouge, vert, jaune, violet, vert OTAN  
moyenne: 23 x 20 x 8 cm, bleu, vert OTAN  
grande: 36 x 20 x 8 cm, rouge, vert OTAN

## CHOC

### Poche polyvalente



#### Caractéristiques techniques:

Tissu polyester RIPSTOP  
Fixation MOLLE au dos + velcro  
Dimensions: 10x15x6 cm  
Couleurs: rouge, vert, bleu



## MYSTIC

### Poche triptyque



#### Dimensions

Largeur: 23 cm  
Longueur: 35 cm  
Hauteur: 10 cm

#### Couleurs:

- Rouge (circulatoire)
- Bleue (intubation)
- Verte (pansements)



## WILCO

### Ceinture pelvienne



#### Caractéristiques techniques:

- Nylon 420D doublé PVC noir + arrière en néoprène élastique.
- Fermeture et serrage par velcro.

Dimensions:  
Largeur: de 6,5 à 17,5 cm  
Longueur: 120 cm  
Épaisseur: 0,5 cm  
Couleur: noire (SEC1095)

#### Caractéristiques techniques communes des ampouliers:

- Coque renforcée en matière composite et doublée velours
- Mousse intérieure anti-choc
- Tissu nylon lavable et désinfectable
- Double curseur YKK pour plombage
- Plaques amovibles avec élastiques double pontets pour différentes tailles d'ampoules
- 2 plans imprimés fournis



## STOP 5

### Micro ampoulier

Dimensions: 7 x 11 x 2,5 cm  
Couleur: jaune  
Capacité maxi: 5 ampoules

## STOP 15

### Mini ampoulier

Dimensions: 20 x 8 x 4 cm  
Couleur: jaune  
Capacité maxi: 16 ampoules



## STOP 40

### Petit ampoulier

Dimensions: 25 x 12 x 6 cm  
Couleur: jaune  
Capacité maxi: 40 ampoules



OPT1038



OPT1037

## STOP 100

### Moyen ampoulier



Dimensions: 25x25x7cm  
Couleur: jaune  
Capacité maxi: 100 ampoules

## STOP 140

### Grand ampoulier



Dimensions: 35 x 25 x 8 cm  
Couleur: jaune  
Capacité maxi: 140 ampoules



OPT1032



**3.**

# EXTRACTION CAMOUFLAGE

- TORA: crochet d'extraction
- GOLANIS: filet d'évacuation
- SPAD: brancard d'évacuation polyvalent
- BATMOBILE: couverture d'extraction
- Filets de camouflage



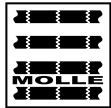

# TORA

## Crochet d'extraction



### Caractéristiques techniques:

- 10 m de sangle
- 4 poignées de traction
- Crochet métallique avec clapet anti-retour

### Couleur:



VERT OLIVE  
(vert OTAN)



# GOLANIS

## Brancard d'évacuation



En dotation officielle

### Caractéristiques techniques:

- Structure souple
- Ultra compact et léger (180 g)
- 2 sangles structurelles polyester de 25 mm
- Sangles polyester de 20mm
- Coutures en croix
- 11 sangles longitudinales
- 11 sangles transversales

### Dimensions:

90 x 180 cm

### Couleur:

-Vert OTAN (SEC1051)



### Couleur:



VERT OLIVE  
(vert OTAN)



# SPAD

Brancard d'évacuation  
polyvalent



**Dimensions:**

- Largeur: 100 cm
- Longueur: 200 cm

**Poids:**

- 340g

**Couleurs:**



**Caractéristiques techniques:**

- Tissu ultra léger ripstop
- Tissu étanche
- 6 poignées de portage



# BATMOBILE

Couverture d'évacuation

**Couleurs:**



**Dimensions du sac de transport:**

- Largeur: 15 cm
- Hauteur: 35 cm
- Profondeur: 12 cm

**Caractéristiques techniques:**

- Tissu haute-résistance 1680 D enduction PVC
- Fond anti-abrasion
- Poignées de traction désaxées
- Anses de traction
- Boucles de serrage bi-latérales avec détrompeur



# Filet de camouflage

tri-dimensionnel et réversible

Pour plus d'informations nous consulter



Développements spécifiques

Couvre-casque sur-mesure



**4.**

# PAQUETAGE

- BARACK: sac de paquetage 100 litres
- WALL: sac polochon
- AIRFORCE: sac de paquetage
- TARMAC: sac de paquetage
- WASH: trousse de toilette
- CRISTAL: pochette de rangement



# BARACK

## Sac de packaging multi-portages

**Dimensions:**  
 Largeur: 78 cm  
 Hauteur: 37 cm  
 Profondeur: 37 cm

**Capacité:**  
 100 litres

**Couleurs:**  
 Noir (PAQ1073)  
 Cam CE (MIL1021)  
 Coyote (MIL1020)



### Caractéristiques techniques:

- Tissu Polyamide 1680 Deniers, imperméable
- 3 compartiments
- Portage à dos, à main, en bandoulière et trolley
- Mousse de confort pour le portage à dos
- Harnais de portage ergonomique totalement amovible
- Bandoulière amovible
- 3 poignées d'extraction
- Très large ouverture en «U» avec accès bi-latéral
- Zipper de grande taille alu YKK taille 12 cadennassable
- Grille d'aération pour chaussures
- Fond doublé PVC
- Filets compartimentés sur les faces intérieures
- Elastiques de maintien des vêtements
- Emplacement velcro pour grade et bande patronymique
- Porte-étiquette dissimulable
- Patch d'identification FRANCE amovible
- Dispositif de maintien d'un trolley

Très large ouverture en «U»  
 avec accès bi-latéral.



Noir



Coyote



Cam CE



# WALL

## Sac de paquetage

PAQ 1087



**Dimensions:**  
Hauteur: 100cm  
Diamètre: 37cm

### Caractéristiques techniques:

- Tissu polyester 600 Deniers traité imperméable
- Fermeture par oeillets
- Poignée renforcée
- Bandoulière fixe

# WASH

## Trousse de toilette

**Dimensions:**  
30 x 35 cm

**Couleurs:**  
-vert OTAN (MIL1015)  
-bleu nuit (PAQ1058)

### Caractéristiques techniques:

- Tissu polyester.
- Porte-étiquette pour le nom
- Miroir incassable en Lexan
- Crochet escamotable
- Serviette fournie
- Gant de toilette fourni
- Multiples pochettes de rangement



# AIRFORCE

## Sac de paquetage

PAQ 1010

**Dimensions:**  
Largeur: 74cm.  
Hauteur: 36cm.  
Profondeur: 36cm

**Capacité:**  
96 litres



### Caractéristiques techniques:

- Tissu Polyamide haute résistance 900 Deniers, imperméable
- Housse en polaire pour casque
- Ouverture en «U»
- Poche portefeuille
- Anneaux de cadenasage
- Grille d'aération des chaussures
- Zipper grande taille alu YKK
- Fond doublé PVC
- Bretelles escamotables pour portage à dos
- Bandes rétro-réfléchissantes

# BARACK

## Sac de paquetage multi-portage

Voir toutes les caractéristiques page 57

**Dimensions:**  
Largeur: 78 cm  
Hauteur: 37 cm  
Profondeur: 37 cm

**Capacité:**  
100 litres



# TARMAAC

## Sac de paquetage

Dimensions intérieures:  
36 x 62 x 26 cm

Dimensions hors tout:  
52 x 77 x 34 cm

Capacité totale:  
100 litres



### Caractéristiques techniques:

- Tissu Polyamide 1680 Deniers imperméable
- Portage à dos: bretelles dissimulables
- Portage à main: deux poignées, arrière et latérale
- Transport trolley: poignée télescopique
- Roulettes intégrées sur la face avant
- 5 poches extérieures avec double zipper YKK taille 10
- 1 poche supérieure amovible pour casque F2
- Mousse du compartiment principal anti-choc
- Fond renforcé PVC.



# CRISTAL

## Pochette polyvalente de rangement



Dimensions petit modèle:  
13 x 20 x 8 cm (MIL2000)

Dimensions moyen modèle:  
23 x 20 x 8 cm (MIL2001)

Dimensions grand modèle:  
36 x 20 x 8cm (MIL2002)

Couleur: vert OTAN



Rabat anti-poussière



Velcro + dispositif de sécurisation sur MOLLE



moyen modèle



petit modèle

### Caractéristiques techniques:

- Oeillet pour plombage
- Poignée tissu
- Réserve pour identification
- Fixation: Velcro + sécurisation MOLLE
- Tissu ripstop

Exemple de configuration dans un sac de combat





**5.**

**DÉVELOPPEMENTS  
SERVICES  
S.A.V.**





# Développements sur-mesures

Nous mettons à votre disposition pour vos développements:

## NOTRE BUREAU D'ÉTUDE:

Grâce aux dessins traditionnels et à la conception assistée par ordinateur (CAO), nous imageons de manière précise vos idées.

## NOTRE ATELIER D'ÉCHANTILLONNAGE:

Nos modélistes confectionnent un prototype fonctionnel en tout point identique à la production pour une mise en test dans les conditions réelles d'utilisation.

## PLUSIEURS SITES DE PRODUCTION:

Nous pouvons produire de une à plusieurs milliers de pièce.

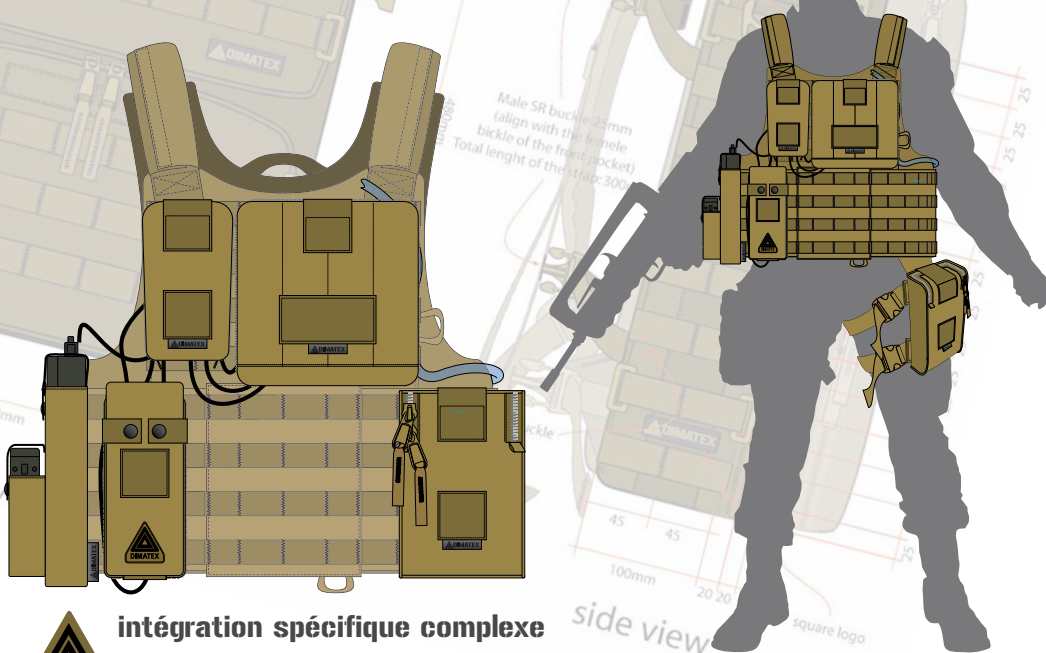

intégration spécifique complexe



## Service Après-Vente

Des couturières spécialisées sont à votre service pour réaliser tous types de réparations sur les produits de la gamme DIMATEX mais aussi sur les produits de nos confrères qui n'offrent pas de SAV.

Pendant la période de garantie et dans le cadre d'une utilisation normale des produits, les réparations sont effectuées gratuitement.

Hors période de garantie, nous vous adressons un devis détaillé, reprenant toutes les réparations à effectuer. Les travaux ne commencent pas sans votre accord (après réception du devis accepté et signé).

Nous disposons d'un stock important de pièces détachées et de matières premières en tout point identiques à celles utilisées pour la production. Ainsi votre produit est réparé à l'identique.

**6.**

**ÉQUIPEMENTS DE  
SECOURS:  
SMU & INCENDIE**



## SENTINEL

Mallette porte-documents  
format A4



## THORAX

Porte-radio universel



Capacité: 2 radios

Caractéristiques techniques:

- Tissu polyamide 1680 Deniers
- Tissu et mesh 3D respirant côté poitrine et dos
- 1 grande poche de rangement zippée
- 1 couvre-radio intégré haute-visibilité / pluie (possibilité d'un couvre-radio non-feu NOMEX)

## TALWEG

Sac d'intervention

Voir toutes les caractéristiques page 8



## TOM

Sac d'intervention

Voir toutes les caractéristiques page 42

Plus de détails dans le catalogue secours

## STAFF, FELIN, PADDOCK

gilets multi-poches, gilets EN471, chasubles d'identification



## MATRIX

Sac d'intervention

Dimensions: 47 x 36 x 17 cm  
Couleurs: rouge et bleu marine



## BAROUD / VERTICAL

Sac d'intervention grande capacité: 95 litres

Dimensions: 56 x 65 x 34 cm  
Couleurs: rouge et bleu marine



## TONIC

Sac d'intervention

Dimensions: 32 x 42 x 20 cm  
Couleurs: rouge et bleu marine



## COYOTE

Sac d'oxygénothérapie

Dimensions: 75 x 50 x 28 cm  
Couleurs: rouge et bleu marine

Plus de détails dans le catalogue secours

Intérieur de sac personnalisable



Anneau d'hélictreuilage

Poche polyvalente



Portage ergonomique réglable



# ATTACK

Ligne d'attaque



Capacité:  
ATTACK 45: 1 longueur de 20m de 45  
ATTACK 70: 1 longueur de 20m de 70

# SHERPA 83

Claie de portage

Voir toutes les caractéristiques page 20



# COLT

Sac à ligne guide



Capacité:  
1 commande à olive de 60mm  
+ 1 coupe-tout  
+ 4 longes de déviation  
+ 3 clefs de dérivation  
+ 2 cales de porte

Plus de détails dans le catalogue secours

# SCALP

Couverture d'extinction

### Caractéristiques:

- Dimensions: 8,50m x 6,25m
- Simple à mettre en oeuvre par 2 personnes
- Limite l'utilisation d'eau
- Ecologique
- Utilisable sur feux de véhicules électriques
- Contient les fumées
- Réutilisable au moins 10 fois



Plus de détails dans le catalogue secours

# TANKER

Sac d'attaque



Capacité:  
4 longueurs de 20m de 45  
+ 1 lance et 1 division



# ***BLACK-LINE***

- RESCUE: couteau
- HELP: lampe
- ALARM: étui de smartphone
- NASDAQ: portefeuille
- COBRA: masque de protection
- SUROBI: gants d'intervention non-feu
- FURTIF: sac pilote
- SCOUT: poche multi-usage
- KAPISA: poche polyvalente
- BAGRAM: poche polyvalente
- MATT: sac 24h
- BARACK: sac de paquetage 100 litres

**7.**



**BLACK-LINE**  
**RESCUE**

Étui + couteau

OPT1109 + SEC1152



**Caractéristiques techniques:**

**Étui:**

- Dimensions: 35x130x13 mm
- Tissu haute-résistance 1680 D Polyamide
- Fixation MOLLE
- Système d'extraction rapide «UpSafe»

**Couteau:**

- Longueur de la lame: 8,5cm / longueur du manche: 12cm
- Poids: 190g
- Manche et lame en acier inoxydable
- Cran de sécurité
- Ouverture / fermeture d'une seule main
- Coupe sangle, marteau brise-vitre



**BLACK-LINE**  
**HELP**

Étui + lampe

OPT1108 + SEC1153

**Caractéristiques techniques:**

**Étui de lampe:**

- Tissu haute-résistance 1680 D
- Fixation MOLLE
- Dimensions : 25x150x20mm

**Lampe torche à LED:**

- Lampe robuste et légère
- Manche en aluminium noir
- Clip métal et sangle de poignet
- Lampe modulable (2 longueurs possibles)
- Fonctionne au choix avec 1 ou 2 piles LR6 AA.



**BLACK-LINE**  
**ALARM**  
Étui de smartphone

OPT1110



**Caractéristiques techniques:**

- Housse de téléphone compatible smartphone
- Dimensions : 63x130x13mm.
- Tissu haute-résistance 1680 D Polyamide.
- Fixation MOLLE.
- Système d'extraction rapide «UpSafe».
- Face avant anti-choc.

**BLACK-LINE**  
**NASDAQ**  
Portefeuille

SEC1156



**Caractéristiques techniques:**

- Tissu haute-résistance 1680 D Polyamide.
- Format passport
- Emplacement sécurisé pour le passport
- Emplacement cartes de crédit
- Poche intérieure zippée
- Fixation MOLLE.

couvre-portefeuille  
intégré



# COBRA BLACK-LINE

## Masque de protection

### Caractéristiques techniques:

- Vision panoramique
- Qualité optique parfaite
- Traitements anti-rayures
- Traitement anti-buée
- Mousse confort interchangeable
- Oculaire en Polycarbonate 2,2 mm galbe 9
- Tresse réglable 14mm
- Poids : 25g
- Etui microfibre 240 x 150 mm / 18 g



### Caractéristiques techniques:

- Tissu 100% ARAMIDE
- Cuir ignifuge et hydrophobe
- Dextérité accrue de l'index
- Coque de protection en composite
- Sangle de serrage du poignet
- Protection des phalanges contre les chocs
- Renfort de la paume
- Renfort spécial tireur
- Système de maintien des gants en attente (en option)



Serrage de la largeur de main  
Protection hypalon du coté de la main

## SUROBI BLACK-LINE

### Gants d'intervention non-feu NOMEX



# FURTIFF BLACK-LINE

## Sac Pilote

Dimensions: 42 x 42cm

### Caractéristiques techniques:

- Tissu Polyester 900 Deniers
- Doublure matelassée, antichoc
- Portage à main (deux poignées)
- Portage en bandoulière (amovible)
- 1 crochet de suspension cabine
- 2 poches extérieures à soufflet
- MOLLE
- Support bande patro, grade et patch



## SCOUT BLACK-LINE

### Poche multi-usage

Dimensions: 20 cm x 13 cm

### Caractéristiques techniques:

- Tissu polyamide 1680 Deniers
- Pochette téléphone & gants latex
- 2 cloisons intérieures
- Porte stylos, stylo pupille...
- MOLLE



### Caractéristiques techniques:

- Fermeture velcro
- Système de fixation MOLLE vertical:
  - vers le haut
  - vers le bas



## JOSS BLACK-LINE

### Poche multi-usage

Voir toutes les caractéristiques page 28



## KAPISA BLACK-LINE

### Poche multi-usage





**BLACK-LINE**  
**MATT**  
 Sac 24h  
 PAQ1080

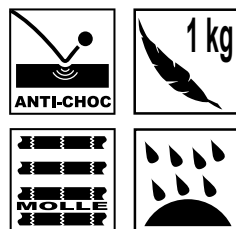

Capacité: 30 litres

**Caractéristiques techniques:**

- Coque semi-rigide
- Fond moussé
- Portage dos largable
- Anneaux de fixation d'une bandoulière
- Clip pour fixation sur sac BARACK
- Système MOLLE
- Velcro pour grade et bande patro
- Patch FRANCE amovible.

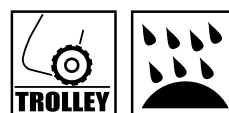

**BLACK-LINE**  
**BARACK**  
 Sac de paquetage  
 PAQ1077

Dimensions:  
 Largeur: 78 cm  
 Hauteur: 37 cm  
 Profondeur: 37 cm

Capacité:  
 100 litres



Présenté ici avec un sac MATT



Voir toutes les caractéristiques page 57





[www.dimatexarmee.fr](http://www.dimatexarmee.fr)

Ce catalogue appartient à:

Nom: .....

Prénom: .....

Matricule: .....

Services: .....



ZA de Montepy, 69210 Fleurieux sur l'Arbresle  
FRANCE

Tél.: 04 74 01 94 94 FAX: 04 74 01 75 26