

PHILIPS

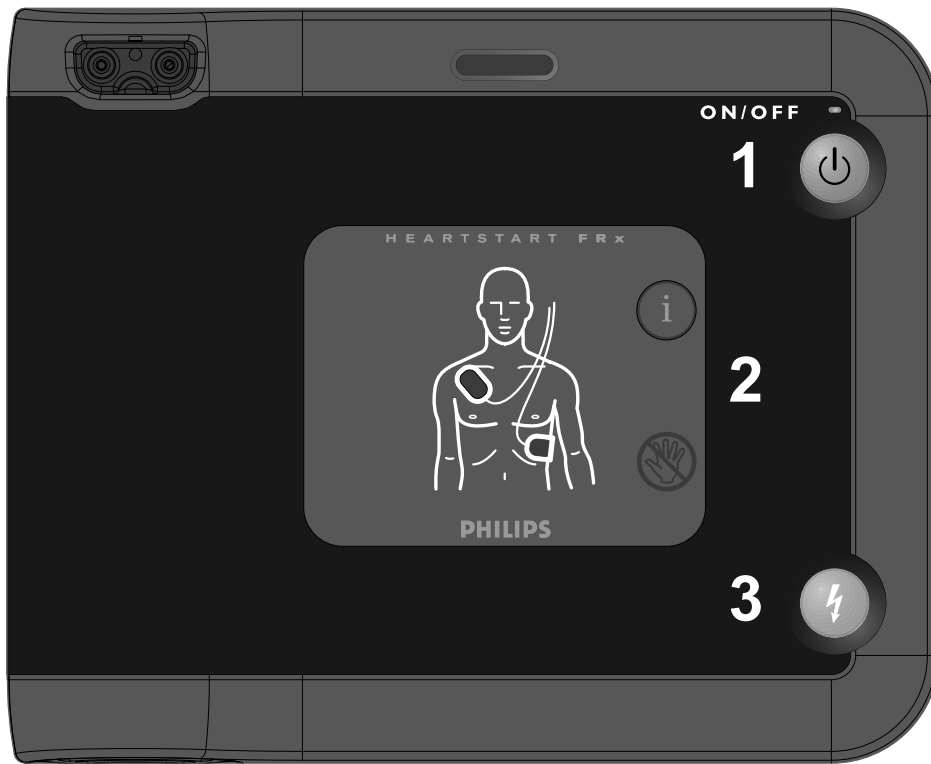

HEARTSTART FRx DEFIBRILLATOR

OWNER'S MANUAL

861304
Edition 8

HEARTSTART
DEFIBRILLATORS

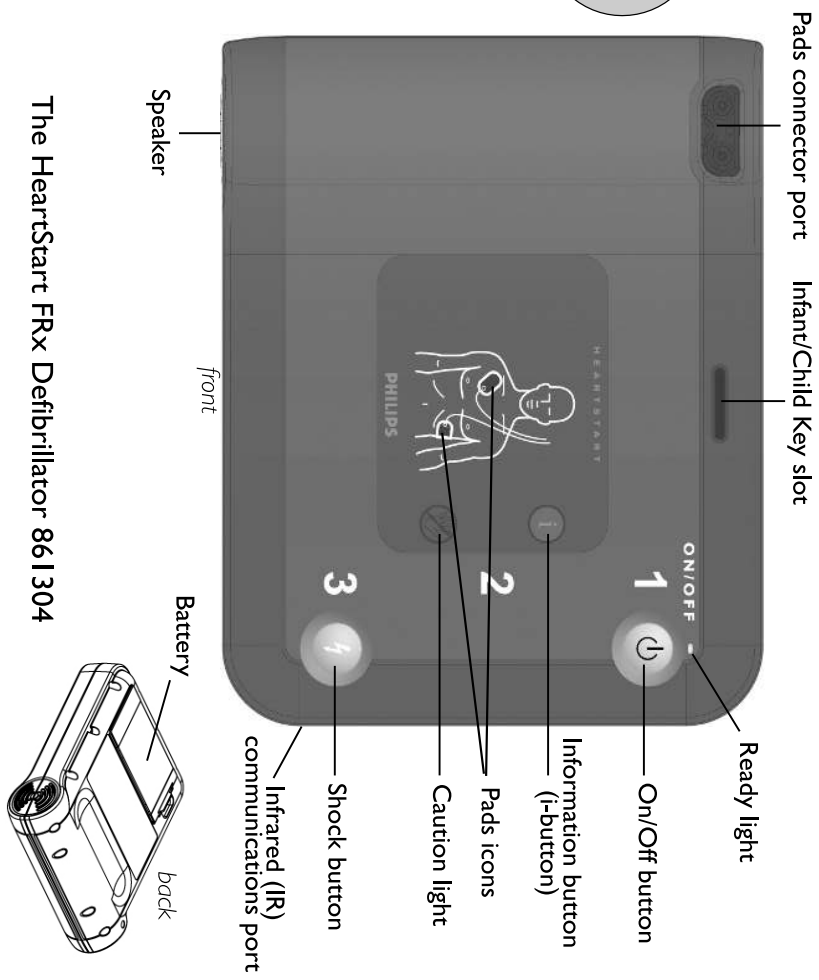
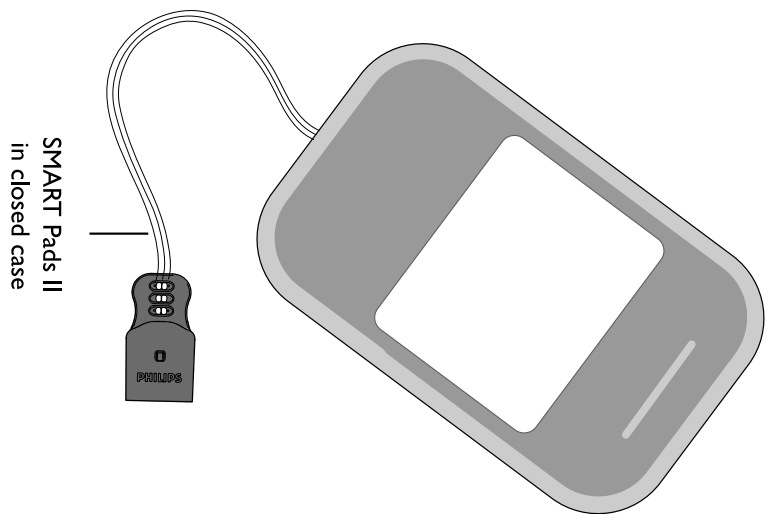

HeartStart FRx Defibrillator QUICK REFERENCE

Check for signs of Sudden Cardiac Arrest:

- Unresponsive
- Not Breathing Normally

1 TURN ON

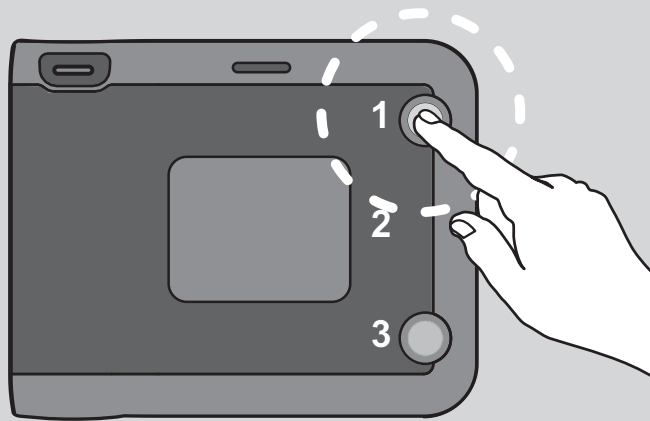

2 PLACE PADS

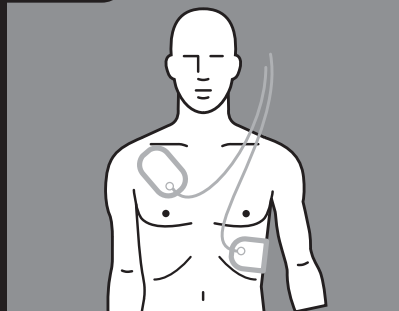

3 PRESS SHOCK

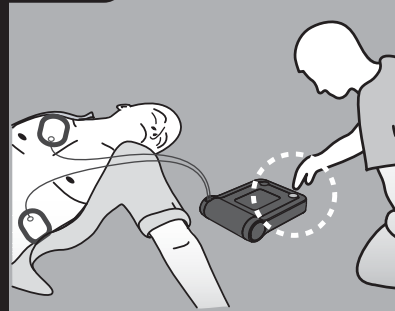

Intentionally blank.

HeartStart FRx

861304

Automated External Defibrillator

OWNER'S MANUAL

Edition 8

IMPORTANT NOTE:

It is important to understand that survival rates for sudden cardiac arrest are directly related to how soon victims are defibrillated. For every minute of delay, the chance of survival declines by 7% to 10%.

Defibrillation cannot assure survival, no matter how rapid the treatment. In some patients, the underlying problem causing the cardiac arrest is simply not survivable despite any available care.

About This Edition

The information in this guide applies to the HeartStart FRx Defibrillator 861304. This information is subject to change. Please contact Philips at www.medical.philips.com/heartstart or your local distributor for information on revisions.

Edition History

Edition 8

Publication date: April 2007

Publication #: 989803138731

Assembly #: 012569-0008

Printed in the USA

Copyright

© 2007 Philips Electronics North America Corp.

No part of this publication may be reproduced, transmitted, transcribed, stored in a retrieval system or translated into any human or computer language in any form by any means without the consent of the copyright holder.

Unauthorized copying of this publication may not only infringe copyright but also reduce the ability of Philips Medical Systems to provide accurate and up-to-date information to users and operators alike.

Authorized EU Representative

Philips Medizin Systeme Boeblingen GmbH
Hewlett-Packard Strasse 2
71034 Boeblingen, Germany
(+49) 7031 463-2254

CAUTION

FEDERAL LAW (USA) RESTRICTS THIS DEVICE TO SALE BY OR ON THE ORDER OF A PHYSICIAN.

The Philips HeartStart is designed to be used only with Philips-approved accessories. The HeartStart may perform improperly if non-approved accessories are used.

Device Tracking

In the USA, this device is subject to tracking requirements by the manufacturer and distributors. If the defibrillator has been sold, donated, lost, stolen, exported, or destroyed, notify Philips Medical Systems or your distributor.

Device Manufacturer

The HeartStart FRx Defibrillator is manufactured by Philips Medical Systems, Seattle, Washington, USA.

Patents

This product is manufactured and sold under one or more of the following United States patents: U.S. Pat. No US6047212, US6317635, US5892046, US5891049, US6356785, US5650750, US6553257, US5902249, US6287328, US6662056, US5617853, US5951598, US6272385, US6234816, US6346014, US6230054, US6299574, US5607454, US5803927, US5735879, US5749905, US5601612, US6441582, US5889388, US5773961, US6016059, US6075369, US5904707, US5868792, US5899926, US5879374, US5632280, US5800460, US6185458, US5611815, US6556864, and other patents pending.

CONTENTS

1	Introduction to the HeartStart FRx	
	Description	1
	Sudden Cardiac Arrest	1
	Indications for Use	2
	Training and practice	2
	State and local requirements	2
	For more information	3
2	Setting up the HeartStart FRx	
	Package contents	3
	Setting up the FRx	4
	Recommended accessories	6
3	Using the HeartStart FRx	
	Overview	7
	STEP 1: Press the green on/off button	8
	STEP 2: Follow the FRx's voice instructions	8
	STEP 3: Press the flashing orange Shock button if instructed	9
	Treating infants and children	10
	When emergency medical services arrive	12
4	After using the HeartStart FRx	
	After each use	14
	FRx data storage	15
5	Maintaining the HeartStart FRx	
	Routine maintenance	16
	Periodic checks	17
	Cleaning the FRx	17
	Disposing of the FRx	17
	Troubleshooting tips	18

APPENDICES

A	Accessories	21
B	Glossary of terms	23
C	glossary of symbols/controls	27
D	Warnings and Precautions	31
E	Technical information	33
F	Configuration	41
G	Testing and troubleshooting	46
H	Additional technical data required for European conformity	50

I Introduction to the HeartStart FRx

Description

The Philips HeartStart FRx Defibrillator 861304 (“FRx”) is an automated external defibrillator (AED). Small, lightweight, rugged, and battery powered, it is designed for simple and reliable operation by minimally trained users. The FRx is highly configurable for local protocol considerations.*

Sudden Cardiac Arrest

The FRx is used to treat ventricular fibrillation (VF), the most common cause of sudden cardiac arrest (SCA). SCA is a condition that occurs when the heart unexpectedly stops pumping. SCA can occur to anyone – young or old, male or female – anywhere, at any time. Many victims of SCA do not have warning signs or symptoms. Some people may have a higher risk for SCA than others. Causes vary and may be different for infants and children than for adults.

VF is a chaotic quivering of the heart muscle that prevents it from pumping blood. The only effective treatment for VF is defibrillation. The FRx treats VF by sending a shock across the heart, so it can start beating regularly again. Unless this is successful within the first few minutes after the heart stops beating, the victim is not likely to survive.

* Configurability includes timing of the “Call Emergency Medical Services” reminder, CPR protocol variations, and other features. See Appendix F, “Configuration,” for details.

Indications for Use

The FRx should be used to treat someone you think may be a victim of SCA. A person in SCA:

- does not respond when shaken, and
- is not breathing normally.

If in doubt, apply the pads. Follow the voice instructions for each step in using the defibrillator.

Training and practice

The FRx is intended to be used under the oversight of a physician as part of a well-designed emergency response plan. Any emergency response plan should provide for training of FRx users in cardiopulmonary resuscitation (CPR) and defibrillator use. Philips recommends that you train on the device you will be using.

Several national and local organizations offer combined CPR/defibrillator training. Contact your Philips representative, or visit us on-line at www.medical.philips.com/heartstart, for information about training programs in your area.

NOTE: Training accessories are available from Philips for practicing use of the FRx. See Appendix A for information on ordering accessories.

State and local requirements

Check with your state health department to see if there are any local or state requirements about owning and using a defibrillator.

For more information

Contact your local Philips distributor for additional information about the FRx. We will be happy to answer any questions you may have and to provide you with copies of the clinical summaries of several key studies using Philips automated external defibrillators.*

You can also find the clinical summaries online at www.medical.philips.com/heartstart. Technical information about all Philips HeartStart automated external defibrillators is also available online, in the *Technical Reference Manual for HeartStart Defibrillators*.

2 Setting up the HeartStart FRx

Package contents

Check the contents of the FRx box to be sure it contains:

- 1 Philips HeartStart FRx Defibrillator 861304
- 1 four-year battery M5070A[†]
- 1 package of HeartStart SMART Pads II 989803139261, containing a pair of single-use adhesive defibrillation pads in a disposable plastic case
- 1 Owner's Manual
- 1 Quick Reference Guide

* Clinical summaries also include defibrillators sold as Heartstream ForeRunner and FR2.

[†] The FRx sold for aviation applications includes a TSO-certified battery, REF: 989803139301, instead of the M5070A.

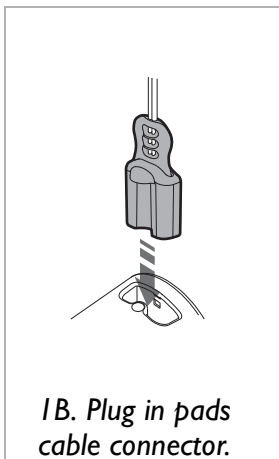
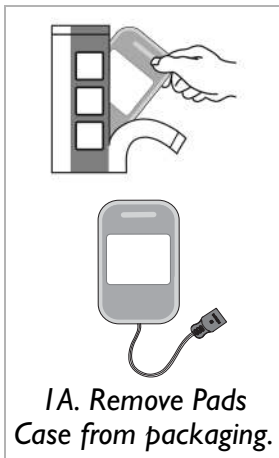

IMPORTANT NOTE: The FRx is designed to be used with a carry case. A number of carry cases are offered to meet the needs of your individual defibrillation program. These include a standard carry case and a hard-shell carry case. See Appendix A for information about these as well as a list of training materials and other accessories available from Philips.

Setting up the FRx

Setting up the FRx is simple and quick.

1. Open the SMART Pads II* package and take out the Pads Case (A). Do not open the pads case until you need to use the pads in an emergency. Plug the pads cable connector into the connector port on the FRx (B). Store the unopened Pads Case in the pocket provided in the defibrillator carry case.
2. Open the battery package and remove the battery. Place the bottom end (A) of the battery into the bottom of the compartment on the back of the FRx, then firmly press down the top (latch) end of the battery into the compartment, until it clicks into place (B).
3. Set the FRx and the Pads Case on a flat surface and let the FRx run its automatic battery insertion self-test. Testing the Shock button and the On/Off button is part of the self-test. The FRx will say “shock button test” and then instruct you to push the Shock button. It will then say “On/Off button test” and instruct you to push the On/Off button. Push the buttons when

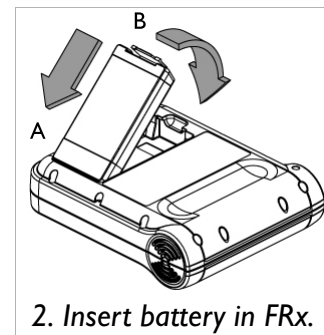

* Unless otherwise noted, references to pads in this document are to HeartStart SMART Pads II.

instructed. When the self-test is over, the FRx will report the results, then turn off and go to standby mode. The blinking green Ready light shows the defibrillator is ready for use.*

4. Place the Quick Reference Guide, a brief illustrated guide for using the FRx to treat a victim of sudden cardiac arrest, in the defibrillator carry case.†

NOTE: Do not store anything in the defibrillator carry case that it is not designed to accommodate. Store all objects in their intended location in the case.

5. Store the FRx in accordance with your site's emergency response protocol. Typically, this will be in a high-traffic area that is easy to access, convenient for checking the Ready light periodically, and easy to hear the alarm chirp if the battery power gets low or the defibrillator needs attention. Ideally, the HeartStart should be stored near a telephone, so the Emergency Response Team or Emergency Medical Services can be alerted as fast as possible in the event of a possible SCA. Keep a spare SMART Pads II cartridge and other accessories with the defibrillator – in the carry case – for quick access when needed. Be sure to store the defibrillator according to its specifications. See Appendix E for details.

NOTE: Always store the FRx with a set of SMART Pads II connected and a battery installed, so it will be ready to use.

* As long as a battery is installed and a set of SMART Pads II is connected, turning the FRx “off” puts it into standby mode, which means that it is ready for use.

† Any of the carry case options has room for storing the Quick Reference Guide.

Recommended accessories

It is always a good idea to have a spare battery and a spare pads set. Other things that are useful to keep with the FRx include:

- scissors — for cutting the victim's clothes if needed
- disposable gloves — to protect the user
- a disposable razor — to shave the chest if hair prevents good pads contact
- a pocket mask or face shield — to protect the user
- a towel or absorbent wipes — to dry the victim's skin for good pads contact

Philips has a Fast Response Kit with all these items. See Appendix A for details.



If you may need to defibrillate an infant or a child under 55 pounds (25 kg) or 8 years old, it is recommended that you order the Infant/Child Key accessory, available separately. When the Infant/Child Key is inserted in the FRx, the FRx automatically reduces the defibrillation energy to 50 joules and, if optional CPR Coaching is selected, provides coaching appropriate for infants and children. Directions for using the Infant/Child Key are provided in Chapter 3, “Using the HeartStart FRx.”

See Appendix A for a list of accessories and training products for the FRx available from Philips.

3 Using the HeartStart FRx

IMPORTANT NOTE: Be sure to read the Reminders section at the end of this chapter as well as the warnings and precautions in Appendix D.

Overview

If you think someone is in SCA, act quickly and calmly. *If someone else is available*, ask him or her to call for emergency medical assistance while you get the FRx. *If you are alone*, follow these steps:

- Call your emergency services provider.
- Quickly get the FRx and bring it to the victim's side. If there is any delay in getting the defibrillator, check the patient and perform cardiopulmonary resuscitation (CPR) if needed until the FRx is available.
- If the victim is an infant or child, see directions for treating infants and children starting on page 10.
- Check the immediate environment for flammable gases. Do not use the FRx in the presence of flammable gases, such as an oxygen tent. However, it is safe to use the FRx on someone wearing an oxygen mask.

There are three basic steps to using the defibrillator to treat someone who may be in sudden cardiac arrest:

1. Press the green On/Off button.
2. Follow the FRx's voice instructions.
3. Press the flashing orange Shock button if instructed.

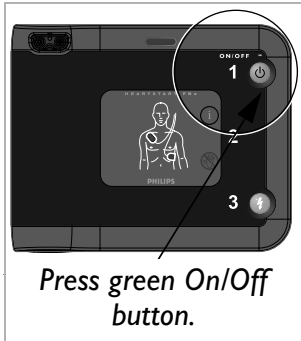

STEP 1: Press the green on/off button

Press the On/Off button  to turn on the FRx.

The FRx tells you to remove all clothes from the person's chest. If necessary, rip or cut off the clothing to bare the person's chest.

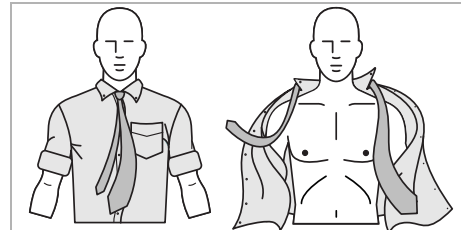

STEP 2: Follow the FRx's voice instructions

Remove the SMART Pads II case from the carry case. Clean and dry the patient's skin, and, if necessary, clip or shave excessive chest hair to ensure good pads contact with the bare skin.

Open the pads case as shown below. Peel off one pad.

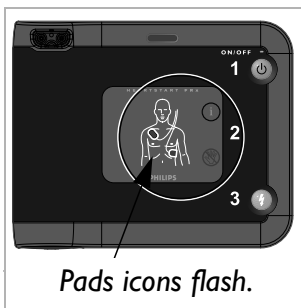
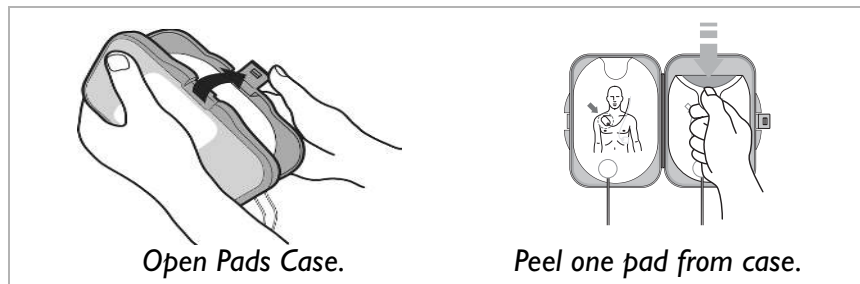

Pads placement is very important. The icons on the pads placement diagram on the FRx front panel will be flashing, to help guide you. Place the pad on the patient's bare skin *exactly as shown* in the following drawing. Press the adhesive portion of the pad down firmly. Then repeat this with the other pad.

Where to place pads on adults and children over 55 pounds or 8 years old (anterior-anterior).

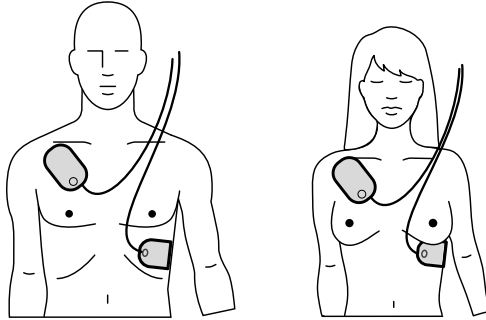

Where to place pads on infants or children under 55 pounds or 8 years old (anterior-posterior).

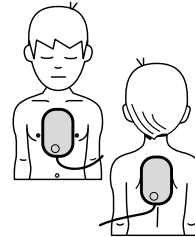

STEP 3: Press the flashing orange Shock button if instructed

As soon as the HeartStart FRx detects that the pads are attached to the patient, the pads icons turn off. The FRx begins analyzing the patient's heart rhythm. It tells you that no one should be touching the patient, and the Caution light begins flashing as a reminder.



If a shock is needed:

The Caution light stops flashing and stays on, and the orange Shock button starts flashing. The FRx tells you to press the flashing orange button. You must press the Shock button for a shock to be delivered. Before you press the button, make sure no one is touching the patient. When you press the Shock button, the FRx tells you that the shock has been delivered. Then the defibrillator tells you it is safe to touch the patient, instructs you to begin CPR, and invites you to press the flashing blue i-button for CPR Coaching if desired.

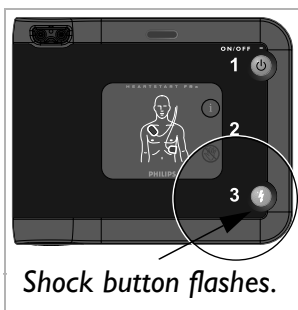
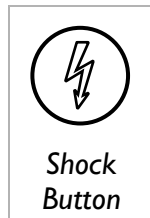

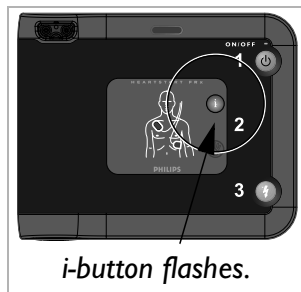

i-button flashes.

If a shock is not needed:

The blue i-button comes on solid, to show that it is safe to touch the patient. The FRx also tells you to perform CPR if needed. (If CPR is not needed – for example, if the patient is moving or regaining consciousness – follow your local protocol until emergency medical personnel arrive.) Then the FRx invites you to press the flashing blue i-button for CPR Coaching if desired.

For CPR Coaching:

Press the flashing blue i-button during the first 30 seconds of the patient care pause to activate CPR Coaching.* (If the Infant/Child Key is inserted, the CPR Coaching provided will be for infant/child CPR.) When the pause is over, the defibrillator tells you to stop CPR, so it can analyze the patient's heart rhythm. The motion caused by CPR can interfere with analysis, so be sure to stop all motion when instructed.



Treating infants and children

WARNING: Most cardiac arrests in children are not caused by heart problems. When responding to cardiac arrest in an infant or child:

- Provide infant/child CPR while a bystander calls EMS and brings the FRx.
- If no bystander is available, provide 1-2 minutes of CPR before calling EMS and retrieving the FRx.
- If you witnessed the child's collapse, call EMS *immediately* and *then* get the FRx.

Alternatively, follow your local protocol.

* The default configuration for the FRx provides CPR Coaching when you press the i-button in this situation; however, the default setting can be revised by your Medical Director using Philips software available separately. See Appendix F for more information.

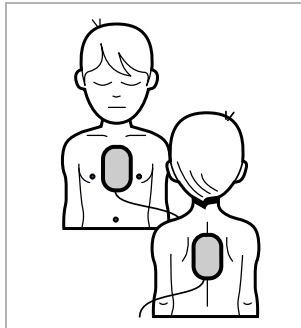
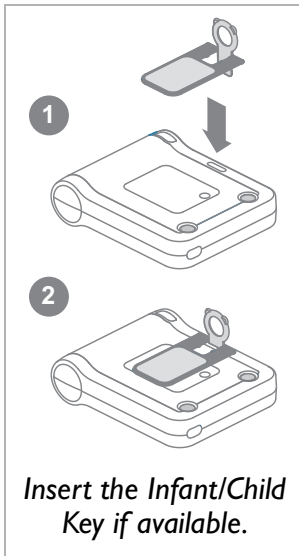

If the victim is under 55 pounds or 8 years old, and you have an Infant/Child Key:

- Insert the Infant/Child Key into the slot at the top center of the front panel of the FRx (see illustration at left). The pink portion of the Key pivots (1) and fits into the slot (2), with the front of the Key lying flat on the surface of the FRx so the infant/child pads placement diagram is visible. (The back of the Infant/Child Key also has a diagram showing how to insert it.)
- Turn on the FRx and follow instructions to remove all clothing from the torso, to bare both the chest and the back.
- Place the pads on the child's front and back, as illustrated. It does not matter which pad is placed on the chest or the back.

NOTE: It does not matter whether you insert the Infant/Child Key before or immediately after turning on the FRx. However, the Key should be inserted before placing the pads on the patient.

With the Infant/Child Key inserted, the FRx will announce "Infant/Child Mode," automatically reduce the defibrillation energy from the adult dose of 150 Joules to 50 Joules,* and provide optional infant/child CPR Coaching.

If the Infant/Child Key is removed during use, the FRx will announce "Adult Mode." Any shocks delivered will be at adult energy, and optional CPR Coaching will be for adult CPR.

* This lower energy level may not be effective for treating an adult.

If the victim is under 55 pounds or 8 years old, but you do NOT have an Infant/Child Key:

- DO NOT DELAY TREATMENT.
- Turn on the FRx and follow instructions to remove all clothing from the torso, to bare both the chest and the back.
- Place the one pad in the center of the chest between the nipples, and the other in the center of the back (anterior-posterior).

If the victim is over 55 pounds or 8 years old, or if you are not sure of the exact weight or age:

- DO NOT DELAY TREATMENT.
- Turn on the FRx without inserting the Key and follow instructions to remove all clothing from the chest.
- Place the pads as illustrated on each pad (anterior-anterior). Make sure the pads do not overlap or touch each other.

When emergency medical services arrive

When Emergency Medical Services (EMS) personnel arrive to care for the patient, they may decide to apply another defibrillator to allow monitoring of the patient. Depending on their equipment, the EMS team may apply different pads. In that case, the SMART Pads II should be removed. EMS personnel may want a summary of the last-use data* stored in the FRx. To hear the summary data, hold down the i-button until the FRx beeps.

NOTE: After the EMS team removes the SMART Pads II from the patient, remove the Infant/Child Key, if used, and install a new pads set before returning the FRx to service, to be sure it is ready for use.

* See Chapter 4, "After Using the HeartStart FRx," for details about data storage.

Reminders

- Remove any medicine patches and residual adhesive from the patient's chest before applying the pads.
- Do not place the pads directly over an implanted pacemaker or defibrillator. A noticeable lump with a surgical scar should indicate the position of an implanted device.
- Do not allow the pads to contact other electrodes or metal parts that are in contact with the patient.
- If the pads do not stick well, check that the pads adhesive has not dried out. Each pad has a layer of adhesive gel. If the gel is not sticky to the touch, replace the pads with a new set. (For ease of handling, the pad is designed with a non-gel area around the connector cable.)
- Keep the patient still and keep any movement around the patient to a minimum during rhythm analysis. Do not touch the patient or the pads while the Caution light is on solid or flashing. If the FRx is unable to analyze due to electrical "noise" (artifact), it will tell you to stop all movement and remind you not to touch the patient. If the artifact continues for more than 30 seconds, the FRx will pause briefly to allow you to deal with the source of the noise, then resume analysis.
- The FRx will only deliver a shock if the flashing orange Shock button is pressed when the instruction is given. If the Shock button is not pressed within 30 seconds after the instruction, the FRx will disarm itself, and (for the first CPR interval) give a reminder to make sure emergency medical services have been called, then begin a CPR interval. This is designed to minimize interruption of CPR and help ensure ongoing patient support.
- While waiting for you to press the Shock button, the FRx will continue to analyze the heart rhythm. If the patient's rhythm changes before you press the Shock button, and a shock is no longer needed, the defibrillator will disarm and tell you a shock is not advised.
- If for any reason you want to turn off the defibrillator during a use, you can press the On/Off button – holding it down for at least one second – to return the device to standby mode.

4 After using the HeartStart FRx

After each use

1. Check the outside of the FRx for signs of damage, dirt, or contamination. If you see signs of damage, contact Philips for technical support. If the defibrillator is dirty or contaminated, clean it according to the guidelines in Chapter 5, “Maintaining the HeartStart FRx.”
2. Plug the cable connector for a new set of SMART Pads II into the FRx (do not open the pads case). Check supplies and accessories for damage and expiration dates. Replace any used, damaged or expired items. For directions on changing the pads and replacing the battery, please see Chapter 2, “Setting Up the HeartStart FRx.” The single-use pads must be replaced after being used.
3. Unless your protocol requires that the battery remain installed, remove the battery for five seconds, then reinstall it to run the battery insertion self-test to check the operation of the defibrillator.* When the test is complete, check that the green Ready light is blinking.
4. Return the FRx to its storage location so it will be ready for use when needed.

* If you leave the battery in the FRx after using the defibrillator, then transfer the last-use data to a computer running HeartStart Event Review software, the software will calculate the local date and time of the device use. However, if you remove the battery prior to transferring the data, the software will only show elapsed time.

FRx data storage

The FRx automatically stores data about its last clinical use in its internal memory. The stored data can be conveniently transferred to a personal computer or a handheld computer running the appropriate application in the Philips HeartStart Event Review data management software suite. Event Review software is for use by trained personnel only. Information about HeartStart Event Review is available online www.medical.philips.com/goto/eventreview.

Follow your local protocol with regard to prompt data transfer for medical review after using the FRx.* Details about data transfer and timing are provided in Event Review documentation.

The information automatically stored by the FRx includes a summary of last-use data and detailed data about its last clinical use. You can get a voice summary of information about the last use of the defibrillator by holding the i-button down until it beeps once. The FRx will tell you how many shocks were delivered and how long it has been since it was turned on. Summary data are available anytime the defibrillator is ready for use (the battery and pads are installed, and the defibrillator is not turned on) or while it is actually in use. Removing the battery erases the summary data for the last use.

Last-use data stored in internal memory include:

- ECG recordings (a maximum of 15 minutes following pads application†)

* The FRx automatically stores information about its last clinical use in its internal memory for at least 30 days, so the data can be downloaded to a computer running appropriate Event Review software. (If the battery is removed during this period, the defibrillator retains the files. When the battery is reinstalled, the last-use ECG recording will be kept in defibrillator memory for an additional 30 days.) After this time, the last-use ECG recordings will automatically be erased to prepare for a future use.

† If ECG recordings from a previous use have not been erased, the maximum time for new ECG recordings may be less.

- the FRx's status (entire incident)
- the FRx's rhythm analysis decisions (entire incident)
- the elapsed time associated with stored events (entire incident)

5 Maintaining the HeartStart FRx

Routine maintenance

The FRx is very simple to maintain. The defibrillator performs a self-test every day. In addition, a battery insertion self-test is run whenever a battery is installed in the device. The defibrillator's extensive automatic self-test features eliminate the need for any manual calibration.

WARNING: *Electrical shock hazard.* Do not open the FRx, remove its covers, or attempt repair. There are no user-serviceable components in the FRx. If repair is required, return the FRx to an authorized service center.

Reminders:

- Do not leave the defibrillator without a set of pads connected; the defibrillator will start chirping and the i-button will start flashing.
- Do not store the FRx with the Infant/Child Key installed.
- The FRx runs daily self-tests. As long as the green Ready light is blinking, it is **NOT** necessary to test the defibrillator by initiating a battery insertion self-test. This uses battery power and risks draining the battery prematurely.

Periodic checks

Other than the checks recommended after each use of the FRx, maintenance is limited to periodically checking the following:

- Check the green Ready light. If the green Ready light is not blinking, see Troubleshooting Tips, below.
- Replace any used, damaged or expired supplies and accessories.
- Check the outside of the defibrillator. If you see cracks or other signs of damage, contact Philips for technical support.

Cleaning the FRx

The outside of the HeartStart FRx can be cleaned with a soft cloth dampened in soapy water, chlorine bleach (2 tablespoons per quart or liter of water), ammonia-based cleaners, or 70% isopropyl (rubbing) alcohol. It is recommended that the carry case be cleaned with a soft cloth dampened in soapy water.

Reminders:

- Do not use strong solvents such as acetone or acetone-based cleaners, abrasive materials, or enzymatic cleaners to clean the FRx and accessories.
- Do not immerse the FRx in fluids. Do not sterilize the FRx or its accessories.

Disposing of the FRx

The FRx and its accessories should be disposed of in accordance with local regulations.

Troubleshooting tips

The FRx's green Ready light is your guide to knowing if the defibrillator is ready for use.

- If the Ready light is blinking: The FRx has passed the battery insertion self-test and the last periodic self-test and is therefore ready for use.
- If the Ready light is solid: The FRx is in use or running a self-test.
- If the Ready light is off, the FRx is chirping, and the i-button is flashing: A self-test error has occurred, there is a problem with the pads, the Infant/Child Key has been left installed, or the battery power is low. Press the i-button for instructions.
- If the Ready light is off but the FRx is not chirping and the i-button is not flashing: there is no battery inserted, the battery is depleted, or the defibrillator needs repair. Insert/replace battery and run the self-test. As long as the FRx passes the self-test, you can be assured it is ready for use.

More detailed testing and troubleshooting information is available in Appendix G.

APPENDICES

- A Accessories
- B Glossary of terms
- C Glossary of symbols/controls
- D Warnings and precautions
- E Technical information
- F Configuration
- G Testing and troubleshooting
- H Additional technical data required for European conformity

Notes

A Accessories

Accessories* for the HeartStart FRx Defibrillator 861304 available separately from your local Philips representative or online at www.medical.philips.com/heartstart include.

- Batteries (spare is recommended)
 - Battery [REF: M5070A]
 - Aviation applications battery [REF: 989803139301]
- HeartStart SMART Pads II [REF: 989803139261] (spare is recommended)
- Carry Cases
 - FRx carry case [REF: 989803139251]
 - Hard-shell carry case [REF: YC]
- Cabinets and Mounts
 - Wall mount bracket [REF: M3857A]
 - Defibrillator cabinet, semi-recessed [REF: PFE7023D]
 - Defibrillator cabinet, wall surface mount [REF: PFE7024D]
 - Defibrillator cabinet, basic [REF: 989803136531]
- Infant/Child Key [REF: 989803139311]
- Fast Response Kit (pouch containing a pocket mask, a disposable razor, 2 pairs of disposable gloves, a pair of paramedic's scissors, and an absorbent wipe) [REF: 68-PCHAT]
- Data Management Software
 - HeartStart Configure PDA software [REF: 989803143041]
 - HeartStart Case Capture PDA software [REF: 989803143051]
 - HeartStart Review Express Connect [REF: 861311 option A01]
 - HeartStart Event Review, single-PC license [REF: M3834A]
 - HeartStart Event Review, organization-wide license [REF: 989803141811]
 - HeartStart Event Review Pro, single-PC license [REF: 861276 option A01]
 - HeartStart Event Review Pro, three-PC license [REF: 861276 option A02]
 - HeartStart Event Review Pro, organization-wide license [REF: 861276 option A03]

* Certain accessories require a prescription in the United States.

- Infrared adapter for use with HeartStart Event Review software [REF: ACT-IR]
- HeartStart FRx Defibrillator Quick Reference Guide [REF: 989803138601]
- Training
 - HeartStart Training Pads II (kit containing one set of Training Pads II in training pads case, adult pads placement guide, Instructions for Use, and illustrated guide) [REF: 989803139271]
 - Replacement Training Pads II (pair of training pads on disposable liner for use in training pads case provided with HeartStart Training Pads II) [REF: 989803139291]
 - Adult pads placement guide [REF: M5090A]
 - Infant/Child pads placement guide [REF: 989803139281]
 - HeartStart FRx Defibrillator Instructor's Training Toolkit, NTSC [REF: 989803139321] or PAL [REF: 989803139331]
 - HeartStart FRx Defibrillator Training DVD [REF: 989803139341]
 - Internal Manikin Adapter [REF: M5088A]
 - External Manikin Adapter, 10 pack [REF: M5089A]

B Glossary of terms

The terms listed in this Glossary are defined in the context of the Philips HeartStart FRx Defibrillator 861304 and its use.

AED	Automated external defibrillator (a semi-automatic defibrillator).
AED mode	The standard treatment mode for the HeartStart FRx Defibrillator. It provides voice instructions guiding the rescuer through applying the adhesive pads, waiting for rhythm analysis, and delivering a shock if needed.
analysis	See “SMART analysis.”
arrhythmia	An unhealthy, often irregular, beating of the heart.
artifact	Electrical “noise” caused by sources such as muscle movements, CPR, patient transport, or static electricity that may interfere with rhythm analysis.
battery	The sealed lithium manganese dioxide battery used to power the HeartStart FRx Defibrillator. It is provided in a pack that fits into a compartment on the back of the defibrillator.
Caution light	A light on the front of the HeartStart FRx Defibrillator that flashes during rhythm analysis and is on solid when a shock is advised, as a reminder not to touch the patient
configuration	The settings for all operating options of the HeartStart FRx Defibrillator, including treatment protocol. The factory default configuration can be modified by authorized personnel using HeartStart Event Review software.
CPR	Cardiopulmonary resuscitation. A technique for providing artificial respiration and heart compressions.
CPR Coaching	Basic verbal instructions for performing cardiopulmonary resuscitation, including hand placement, rescue breathing, compression depth and timing, provided by the FRx when the flashing blue i-button is pressed during the first 30 seconds of a patient care pause.
defibrillation	Termination of cardiac fibrillation by applying electrical energy.
ECG	Electrocardiogram, a record of the electrical rhythm of the heart as detected through defibrillation pads.
fibrillation	A disturbance of the normal heart rhythm that results in chaotic, disorganized activity that cannot effectively pump blood. Ventricular fibrillation (fibrillation in the lower chambers of the heart) is associated with sudden cardiac arrest.









HeartStart Event Review	A suite of data management software applications for use by trained personnel to review and analyze FRx Defibrillator patient use and by authorized personnel to alter FRx configuration. Information is available from Philips Medical Systems on the internet at http://www.medical.philips.com/goto/eventreview .
i-button	A blue “information” button on the front of the HeartStart FRx Defibrillator. If the i-button is pressed during the 30 seconds it flashes during a patient care pause, the FRx provides CPR Coaching;* if the i-button is pressed when it is flashing and the FRx is chirping, the FRx provides troubleshooting guidance. At other times, if the i-button is pressed and held until it beeps once, the FRx provides summary information about its last clinical use and device status. When the i-button is on solid (not flashing), it indicates the user may safely touch the patient.
Infant/Child Key	A “key” recommended for use when defibrillating a potential SCA victim under 55 pounds or 8 years old. When inserted into a dedicated slot on the FRx’s front panel, the Infant/Child Key illustrates correct pads placement, with lighted icons, on these young victims. With the Infant/Child Key inserted, the HeartStart FRx automatically reduces the energy of any shock delivered to 50 J and provides CPR Coaching, if selected, appropriate for infants and children.
infrared (IR) communications	A method of sending information using a special part of the light spectrum. It is used to transmit information between the HeartStart FRx Defibrillator and a computer running HeartStart Event Review software.
NSA	“No Shock Advised,” a decision made by the HeartStart FRx Defibrillator that a shock is not needed, based on analysis of the patient’s heart rhythm.
NSA pause	A pause provided by the HeartStart FRx Defibrillator following an No Shock Advised (NSA) decision. The pause can be configured to a “standard” NSA pause or a “SMART” NSA pause. During a standard NSA pause the defibrillator performs no background monitoring of patient rhythm. During a SMART NSA pause, the defibrillator conducts background monitoring and, if it detects an artifact-free shockable rhythm, will exit the pause and begin rhythm analysis. If the HeartStart FRx detects artifact such as that created by CPR, or if the user presses the i-button for CPR Coaching during a SMART NSA pause, the defibrillator will not exit the pause for rhythm analysis in order to allow CPR to be completed uninterrupted.
non-shockable rhythm	A heart rhythm that the HeartStart FRx Defibrillator determines is not appropriate for defibrillation.

* Pressing the i-button for CPR Coaching during a SMART NSA pause turns off background monitoring.









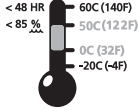

On/Off button	A green button located on the front of the HeartStart FRx Defibrillator. Pressing the On/Off button when the defibrillator is in standby mode turns the defibrillator on; pressing and holding the On/Off button for one second when the defibrillator is on turns the defibrillator off and disarms the defibrillator. In addition, pressing the On/Off button stops the battery insertion self-test that automatically runs when a battery is inserted.
pads	See “SMART Pads II.”
patient care pause	A defined period to allow CPR. See “NSA pause” and “protocol pause.”
periodic self-tests	Daily, weekly, and monthly tests automatically conducted by the HeartStart FRx Defibrillator when it is in its standby mode. The tests monitor many key functions and parameters of the defibrillator, including battery capacity, pads readiness, and the state of its internal circuitry.
protocol	A sequence of operations performed by the HeartStart FRx Defibrillator to direct patient care in the AED mode.
protocol pause	A period provided by the HeartStart FRx Defibrillator after a shock series, during which the responder can administer CPR. The defibrillator does not conduct background monitoring of the patient’s heart rhythm during this pause.
Quick Shock	The ability of the FRx to deliver a defibrillation shock very quickly – typically within 8 seconds – after the end of a patient care pause.
Ready light	A green LED showing the readiness for use of the HeartStart FRx Defibrillator. A blinking Ready light means the defibrillator is ready for use; a solid Ready light means the defibrillator is being used.
rhythm analysis	See “SMART analysis.”
Shock button	An orange button with a lightning bolt symbol on it, located on the front of the HeartStart FRx Defibrillator. The Shock button flashes when a shock is advised. You must press the button for the shock to be delivered.
shockable rhythm	A heart rhythm that the HeartStart FRx Defibrillator determines is appropriate for defibrillation, such as ventricular fibrillation and some ventricular tachycardias associated with sudden cardiac arrest.
SMART analysis	The proprietary algorithm used by the HeartStart FRx Defibrillator to analyze the patient’s heart rhythm and determine whether a shock is advised.
SMART biphasic waveform	The patented, low-energy defibrillation shock waveform used by the HeartStart FRx Defibrillator. It is an impedance-compensated biphasic waveform. It delivers 150 Joules, nominal, into a 50 ohm load; when the Infant/Child Key is inserted, it delivers 50 Joules, nominal, into a 50 ohm load.





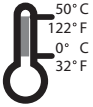

SMART NSA pause	See “NSA pause.”
SMART Pads II	The adhesive pads used with the HeartStart FRx Defibrillator to defibrillate patients of any age or weight. The pads are applied to the patient’s bare skin and used to detect the patient’s heart rhythm and to transfer the defibrillation shock.
standby mode	The operating mode of the HeartStart FRx Defibrillator when a battery has been installed, and the unit is turned off and ready for use when needed. Shown by blinking green READY light.
standard NSA pause	See “NSA pause.”
sudden cardiac arrest (SCA)	The sudden stopping of the heart’s pumping rhythm, accompanied by loss of consciousness, absence of respiration, and lack of a pulse.
waveform	See “SMART biphasic waveform.”

C Glossary of symbols/controls

symbol	description
	On/Off button. Green. Pressing the On/Off button when the defibrillator is in standby mode turns the defibrillator on; pressing and holding the On/Off button for one second when the defibrillator is on turns the defibrillator off and disarms the defibrillator. In addition, pressing the On/Off button stops the battery insertion self-test that automatically runs when a battery is inserted.
	Information button (i-button). Blue. Pressing the i-button while it is flashing during a patient care pause provides CPR Coaching in default configuration; pressing it while it is flashing and the defibrillator is chirping provides troubleshooting guidance. Pressing it until it beeps at other times provides summary information about the defibrillator's last clinical use. Pressing it briefly in standby mode gives device status.
	Caution light. Flashes during rhythm analysis, and is on but not flashing when a shock is advised, as a reminder not to touch the patient.
	Shock button. Orange. If a shock is needed, flashes when the defibrillator is charged. The defibrillator directs the user to press the Shock button to deliver a shock to the patient.
	Refer to operating instructions.
	Lithium manganese dioxide battery.
TSO C-142	TSO C-142 certified battery (989803139301 only)
 QTY (1)	One battery in package.
	Do not crush the battery.

symbol	description
	Do not expose the battery to high heat or open flames. Do not incinerate the battery.
	Do not mutilate the battery or open the battery case.
	Do not expose to moisture.
	Handle with care.
	This side up.
	Defibrillation protection. Defibrillation protected, type BF patient connection.
IP55	Meets IEC 529 class IPx5 for sealing against jetting water and class IP5x for sealing against solid objects (dust protected).
	Certified by the Canadian Standards Association.
	Meets the requirements of the European medical device directives 93/42/EEC.
	Meets the requirements of the applicable European directive.
	Printed on recycled paper.
	Storage requirements (refer to associated thermometer symbol).
	Transportation requirements (refer to associated thermometer symbol).

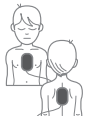
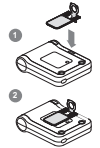
symbol	description
	Environmental (temperature and relative humidity) requirements.
	Install the battery in the defibrillator before the date (MM-YYYY) shown on the associated label.
	Reference order number.
	Serial number.
	Lot number.
	Date of manufacture (989803139301 only)
	Class 9 miscellaneous dangerous goods. (Symbol required on outer packaging by freight carrier regulations to identify shipments containing lithium batteries.)
	On HeartStart SMART Pads II (989803139261 only). These pads are disposable and are for single patient use only.
	Contents: one set of two defibrillation pads.
	Store the pads at temperatures between 32° and 122° F (0° and 50° C).
	This product does not contain natural rubber latex.
	This product is not sterile.

symbol	description
	Replace pads after 24 hours.
	Expiration (refer to associated date code).
MM - YYYY	Expiration date.
Rx only	Federal law (USA) restricts this device to sale by or on the order of a physician.
	Not for use with Laerdal defibrillator models 911, 1000, 2000, or 3000.
	Not for use with HeartStart HS1 defibrillators, including HeartStart Home and HeartStart OnSite.
	Fits Philips HeartStart designated connector ports, including FR2+ and MRx.
	Pads placement illustration.
< 55 LBS / 25 KG	For use on infants and children under 55 pounds (25 kg).
	Insert Infant/Child Key into slot on FRx.
	Dispose of in accordance with your national or local requirements.
	Indicates that this device is optimized for Guidelines 2005.

D Warnings and Precautions

It is important to understand how to use your HeartStart FRx Defibrillator safely. Please read these warnings and precautions carefully.

A **warning** describes something that could cause serious personal injury or death. A **precaution** describes something that could cause minor personal injury, damage to the FRx, loss of data stored in the FRx, or less chance of successful defibrillation.

NOTE: The HeartStart FRx Defibrillator is designed to be used only with Philips-approved accessories. The FRx may perform improperly if non-approved accessories are used.

Warnings

flammable gases	If the FRx is used to give a shock in the presence of flammable gases such as in an oxygen tent, there is a risk of explosion. Move supplemental oxygen and oxygen delivery devices away from the defibrillation pads. (However, it is safe to use the FRx on someone wearing an oxygen mask.)
battery	The HeartStart M5070A and 989803139301 batteries are not rechargeable. Do not try to recharge, open, crush, or burn the battery, or it may explode or catch fire.
fluids	Do not let fluids get into the FRx. Avoid spilling any fluids on the FRx or its accessories. Spilling fluids into the FRx may damage it or cause a fire or shock hazard. Do not sterilize the FRx or its accessories.
accessories	Using damaged or expired equipment or accessories may cause the HeartStart FRx Defibrillator to perform improperly, and/or injure the victim or the user.
patient handling	Performing CPR or otherwise handling or moving the patient while the FRx is analyzing heart rhythm can cause an incorrect or delayed analysis. If the FRx tells you a shock is advised while you are handling or moving the patient, stop the vehicle or CPR and keep the patient as still as possible for at least 15 seconds. This will give the FRx time to reconfirm the analysis before telling you to press the Shock button.
cell phones	The FRx can work correctly when it is fairly close to equipment like emergency two-way radios and cell phones. Normally, using a cell phone near the patient should not cause a problem for the FRx. However, it is best to keep such equipment only as close as necessary to the patient and the FRx.

pads Do not allow the pads to contact other electrodes or metal parts that are in contact with the patient.

Precautions

- device handling The FRx was designed to be sturdy and reliable for many different use conditions. However, handling the FRx too roughly can damage it or its accessories and will invalidate the warranty. Check the FRx and accessories regularly for damage, according to directions.
- maintenance Improper maintenance may damage the FRx or cause it to function improperly. Maintain the FRx according to directions.
- skin burns Do not let the pads touch each other or other electrodes, lead wires, dressings, medicine patches, etc. Such contact can cause electrical arcing and skin burns during a shock and may also divert the electrical current away from the patient's heart. During a shock, air pockets between the skin and pads can cause skin burns. To help prevent air pockets, make sure pads stick well to the skin. Do not use dried out pads because they will not provide good contact with the skin.
- patient handling Before delivering a shock, it is important to disconnect the patient from other medical electrical equipment, such as blood-flow meters, that may not incorporate defibrillation protection. In addition, make sure the pads are not in contact with metal objects such as a bed frame or stretcher.

E Technical information

HeartStart FRx 861304 Defibrillator specifications

The specifications provided in the following tables are nominal values. Additional information can be found in the *Technical Reference Manual* for HeartStart Defibrillators, located online at www.medical.philips.com.

Physical

category	specifications
size	2.4" H x 7.1" D x 8.7" W (6 cm H x 18 cm D x 22 cm W).
weight	Approximately 3.5 lbs (1.6 kg) with battery and pads installed.
pads compatibility	HeartStart SMART Pads II 989803139261 (In an emergency or during use, HeartStart DP2/DP6 pads may be used. However, the FRx should not be stored with DP2/DP6 pads installed, as the daily self-test will not give a "pass" result and the device will chirp.)

Environmental

category	specifications
temperature and relative humidity	Operating and standby (battery installed, pads connected): 32° to 122° F (0° to 50° C); 10% to 75% RH (non-condensing). Storage/shipping (with battery and pads case): -4° to 140° F (-20° to 60° C) for up to 1 week; 0% to 85% RH (non-condensing) for up to 2 days, thereafter 65% RH maximum
altitude	0 to 15,000 feet (0 to 4,572 m).
shock/drop abuse tolerance	Withstands 1 meter drop on any edge, corner, or face of the device onto masonry surface.
vibration	Operating: meets MILSTD 810F Fig. 514.5C-17, random. Standby: meets MILSTD 810F Fig. 514.5C-18, swept sine (helicopter).

category	specifications
sealing	Meets IEC 529 class IPx5 for jetting water and class IP5x for solid objects (dust protected).
ESD/EMI (radiated and immunity)	See Appendix F.
aircraft: method	Meets RTCA/DO-160D:1997 Section 21 (Category M - Charging).

Controls and indicators

category	specifications
controls	Green On/Off button Blue i-button Orange Shock button Optional Infant/Child Key accessory
indicators	Ready light: green, blinks when the defibrillator is in standby mode (ready for use); solid when the defibrillator is being used. i-button: blue, flashes when information is available, on solid during patient care pause. Caution light: flashes when the defibrillator is analyzing, comes on solid when the defibrillator is ready to deliver a shock. Shock button: orange, flashes when the defibrillator is charged and ready to deliver a shock. Pads Placement LEDs: flash when FRx is turned on; off once pads are placed on patient. Also operates with Infant/Child Key inserted to indicate pads placement on infants and children under 55 pounds (25 kg) or 8 years old.
audio speaker	Provides voice instructions and warning tones during normal use.
beeper	Provides chirps when troubleshooting is needed.
status indicator	Status indicator LCD displays device readiness for use.
low battery detection	Automatic during daily periodic self-testing.
low battery indicator	Alarm chirps and flashing blue in-button.

Defibrillation waveform

category	nominal specifications																																																																																																												
waveform parameters 	<p>Biphasic truncated exponential. Waveform parameters are automatically adjusted as a function of patient defibrillation impedance. In the diagram at left, D is the duration of phase 1 and E is the duration of phase 2 of the waveform, F is the interphase delay (500 μs), and I_p is the peak current.</p> <p>The HeartStart FRx delivers shocks to load impedances from 25 to 180 ohms. The duration of each phase of the waveform is dynamically adjusted based on delivered charge, in order to compensate for patient impedance variations, as shown below:</p> <table border="1"> <thead> <tr> <th colspan="6">adult defibrillation</th> </tr> <tr> <th>load resistance (Ω)</th> <th>phase 1 duration (ms)</th> <th>phase 2 duration (ms)</th> <th>peak current (A)</th> <th colspan="2">delivered energy (J)</th> </tr> </thead> <tbody> <tr><td>25</td><td>2.8</td><td>2.8</td><td>65</td><td colspan="2">128</td></tr> <tr><td>50</td><td>4.5</td><td>4.5</td><td>40</td><td colspan="2">150</td></tr> <tr><td>75</td><td>6.25</td><td>5.0</td><td>30</td><td colspan="2">155</td></tr> <tr><td>100</td><td>8.0</td><td>5.3</td><td>24</td><td colspan="2">157</td></tr> <tr><td>125</td><td>9.65</td><td>6.4</td><td>21</td><td colspan="2">159</td></tr> <tr><td>150</td><td>11.5</td><td>7.7</td><td>18</td><td colspan="2">160</td></tr> <tr><td>175</td><td>12.0</td><td>8.0</td><td>16</td><td colspan="2">158</td></tr> </tbody> </table> <table border="1"> <thead> <tr> <th colspan="6">pediatric defibrillation (using Infant/Child Key 989803139311)</th> </tr> <tr> <th>load resistance (Ω)</th> <th>phase 1 duration (ms)</th> <th>phase 2 duration (ms)</th> <th>peak current (A)</th> <th colspan="2">delivered energy (J)</th> </tr> </thead> <tbody> <tr><td>25</td><td>2.8</td><td>2.8</td><td>35</td><td colspan="2">43.4</td></tr> <tr><td>50</td><td>4.5</td><td>4.5</td><td>22</td><td colspan="2">50.2</td></tr> <tr><td>75</td><td>6.3</td><td>5.0</td><td>16</td><td colspan="2">51.8</td></tr> <tr><td>100</td><td>8.0</td><td>5.3</td><td>13</td><td colspan="2">52.4</td></tr> <tr><td>125</td><td>9.0</td><td>6.0</td><td>11</td><td colspan="2">52.3</td></tr> <tr><td>150</td><td>9.0</td><td>6.0</td><td>10</td><td colspan="2">50.2</td></tr> <tr><td>175</td><td>9.0</td><td>6.0</td><td>9</td><td colspan="2">48.1</td></tr> </tbody> </table>	adult defibrillation						load resistance (Ω)	phase 1 duration (ms)	phase 2 duration (ms)	peak current (A)	delivered energy (J)		25	2.8	2.8	65	128		50	4.5	4.5	40	150		75	6.25	5.0	30	155		100	8.0	5.3	24	157		125	9.65	6.4	21	159		150	11.5	7.7	18	160		175	12.0	8.0	16	158		pediatric defibrillation (using Infant/Child Key 989803139311)						load resistance (Ω)	phase 1 duration (ms)	phase 2 duration (ms)	peak current (A)	delivered energy (J)		25	2.8	2.8	35	43.4		50	4.5	4.5	22	50.2		75	6.3	5.0	16	51.8		100	8.0	5.3	13	52.4		125	9.0	6.0	11	52.3		150	9.0	6.0	10	50.2		175	9.0	6.0	9	48.1	
adult defibrillation																																																																																																													
load resistance (Ω)	phase 1 duration (ms)	phase 2 duration (ms)	peak current (A)	delivered energy (J)																																																																																																									
25	2.8	2.8	65	128																																																																																																									
50	4.5	4.5	40	150																																																																																																									
75	6.25	5.0	30	155																																																																																																									
100	8.0	5.3	24	157																																																																																																									
125	9.65	6.4	21	159																																																																																																									
150	11.5	7.7	18	160																																																																																																									
175	12.0	8.0	16	158																																																																																																									
pediatric defibrillation (using Infant/Child Key 989803139311)																																																																																																													
load resistance (Ω)	phase 1 duration (ms)	phase 2 duration (ms)	peak current (A)	delivered energy (J)																																																																																																									
25	2.8	2.8	35	43.4																																																																																																									
50	4.5	4.5	22	50.2																																																																																																									
75	6.3	5.0	16	51.8																																																																																																									
100	8.0	5.3	13	52.4																																																																																																									
125	9.0	6.0	11	52.3																																																																																																									
150	9.0	6.0	10	50.2																																																																																																									
175	9.0	6.0	9	48.1																																																																																																									

category	nominal specifications												
energy	<p>Using HeartStart SMART Pads II for adult defibrillation: 150 J nominal ($\pm 15\%$) into a 50 ohm load.</p> <p>Using HeartStart SMART Pads II with Infant/Child Key inserted: 50 J nominal ($\pm 15\%$) into a 50 ohm load. Sample pediatric energy doses:</p> <table border="1"> <thead> <tr> <th>age</th> <th>energy dose</th> </tr> </thead> <tbody> <tr> <td>newborn</td> <td>14 J/kg</td> </tr> <tr> <td>1 year</td> <td>5 J/kg</td> </tr> <tr> <td>2 - 3 years</td> <td>4 J/kg</td> </tr> <tr> <td>4 - 5 years</td> <td>3 J/kg</td> </tr> <tr> <td>6 - 8 years</td> <td>2 J/kg</td> </tr> </tbody> </table> <p>Doses indicated are based on CDC growth charts for the 50th percentile weights for boys.*</p> <p>* National Center for Health Statistics in collaboration with the National Center for Chronic Disease Prevention and Health Promotion. <i>CDC growth charts: weight-for-age percentiles, revised and corrected</i> November 28, 2000. Atlanta, GA: Centers for Disease Control and Prevention © 2000.</p>	age	energy dose	newborn	14 J/kg	1 year	5 J/kg	2 - 3 years	4 J/kg	4 - 5 years	3 J/kg	6 - 8 years	2 J/kg
age	energy dose												
newborn	14 J/kg												
1 year	5 J/kg												
2 - 3 years	4 J/kg												
4 - 5 years	3 J/kg												
6 - 8 years	2 J/kg												
charge control	Controlled by Patient Analysis System for automated operation.												
shock-to-shock cycle time	< 20 seconds typical, including analysis.												
“charge complete” indicator	Shock button flashes, audio tone sounds; device is able to deliver a shock as soon as a shock is advised.												
patient care pause-to-shock time	Quick Shock. 8 seconds, typical, from end of patient care pause to shock delivery.												
disarm (AED mode)	Once charged, the HeartStart FRx will disarm if: <ul style="list-style-type: none"> • patient’s heart rhythm changes to non-shockable rhythm, • a shock is not delivered within 30 seconds after the FRx is armed, • the On/Off button is pressed for one second to turn off the FRx, • the Infant/Child Key is inserted or removed, • the battery has been removed or is completely depleted, or • the impedance between pads is out of range. 												
adult shock delivery vector	Via SMART Pads II placed in the anterior-anterior (Lead II) position.												
infant/child shock delivery vector	Via SMART Pads II typically placed in the anterior-posterior position.												

ECG analysis system

category	specifications
function	Evaluates impedance of adhesive pads for proper contact with patient skin, and evaluates the ECG rhythm and signal quality to determine if a shock is appropriate.
shockable rhythms	Ventricular fibrillation (VF) and some ventricular tachycardias, including ventricular flutter and polymorphic ventricular tachycardia (VT). The HeartStart FRx Defibrillator uses multiple parameters to determine if a rhythm is shockable. <i>NOTE: Some very low-amplitude or low-frequency rhythms may not be interpreted as shockable VF rhythms. Also, for safety reasons, some VT rhythms often associated with circulation may not be interpreted as shockable rhythms.</i>
non-shockable rhythms	On detection of any non-shockable rhythm, prompts user to perform CPR if needed.
pacemaker detection	Pacemaker artifact is removed from the signal for rhythm analysis.
artifact detection	If electrical “noise” (artifact) is detected that interferes with accurate rhythm analysis, analysis will be delayed until the ECG signal is clean.
analysis protocol	Depending on results of analysis, either prepares for shock delivery or provides a pause. For details of protocol, see Appendix F, “Configuration.”

ECG analysis performance

rhythm class	ECG test sample ^a size	meets AHA recommendations ^b for adult defibrillation	
		observed performance	90% one-sided lower confidence limit
shockable rhythm — ventricular fibrillation	300	sensitivity >90%	(87%)
shockable rhythm — ventricular tachycardia	100	sensitivity >75%	(67%)
non-shockable rhythm — normal sinus rhythm	300	specificity >99%	(97%)
non-shockable rhythm — asystole	100	specificity >95%	(92%)

rhythm class	ECG test sample ^a size	meets AHA recommendations ^b for adult defibrillation observed performance	90% one-sided lower confidence limit
non-shockable rhythm — all other non-shockable rhythms ^c	450	specificity >95%	(88%)

a. From Philips Medical Systems Heartstream ECG rhythm databases.

b. American Heart Association (AHA) AED Task Force, Subcommittee on AED Safety & Efficacy. Automatic External Defibrillators for Public Access Use: Recommendations for Specifying and Reporting Arrhythmia Analysis Algorithm Performance, Incorporation of New Waveforms, and Enhancing Safety. *Circulation* 1997;95:1677-1682.

c. Supraventricular tachycardia (SVT) is specifically included in the non-shockable rhythm class, in accordance with AHA recommendations^b and the AAMI standard DF80.

Accessories specifications

HeartStart SMART Pads II 989803 | 3926 |

category	specifications																					
pads for defibrillation, pacing, monitoring, cardioversion	Disposable, adhesive pads with a nominal active surface area of 80 cm ² each, provided in a disposable plastic case, and an integrated 48 inch (121.9 cm), typical, cable. Pads in case are designed to fit into carry cases.																					
SMART Pads II compatibility	<table border="1"> <thead> <tr> <th>defibrillator model</th> <th>adult patient use</th> <th>infant/child patient use</th> </tr> </thead> <tbody> <tr> <td>FRx*</td> <td>yes</td> <td>yes</td> </tr> <tr> <td>FR2/FR2+</td> <td>yes</td> <td>no, use M3870A</td> </tr> <tr> <td>FR/ForeRunner</td> <td>yes</td> <td>no</td> </tr> <tr> <td>MRx/XL/XLT/4000</td> <td>yes</td> <td>manual mode only</td> </tr> <tr> <td>HSI/OnSite/Home</td> <td>no; use M5071A</td> <td>no; use M5072A</td> </tr> <tr> <td>competitive adapters</td> <td>yes</td> <td>manual mode only</td> </tr> </tbody> </table> <p>* Pre-connectable to FRx defibrillator only.</p>	defibrillator model	adult patient use	infant/child patient use	FRx*	yes	yes	FR2/FR2+	yes	no, use M3870A	FR/ForeRunner	yes	no	MRx/XL/XLT/4000	yes	manual mode only	HSI/OnSite/Home	no; use M5071A	no; use M5072A	competitive adapters	yes	manual mode only
defibrillator model	adult patient use	infant/child patient use																				
FRx*	yes	yes																				
FR2/FR2+	yes	no, use M3870A																				
FR/ForeRunner	yes	no																				
MRx/XL/XLT/4000	yes	manual mode only																				
HSI/OnSite/Home	no; use M5071A	no; use M5072A																				
competitive adapters	yes	manual mode only																				
pads shelf life	Pads package is labeled with a use-by date of at least two years from date of manufacture.																					

M5070A battery and 989803139301 TSO C-142* battery

category	specifications
battery type	9 VDC, 4.2 Ah, lithium manganese dioxide. Disposable, long-life primary cell.
capacity	When new, a minimum of 200 shocks or 4 hours of operating time at 25° C (77° F). (IEC 60601-2-4, 2002)
shelf life (prior to insertion)	A minimum of 5 years from date of manufacture when stored and maintained according to directions provided in this document.
standby life (after insertion)	Typically, 4 years when stored and maintained according to directions provided in this document.
training life	Supports 10 hours of use in training mode.
battery limitations	Never charge, short circuit, puncture, deform, incinerate, heat above 60° C, or expose contents to water. Remove the battery when discharged.
maintenance and calibration requirements for continued airworthiness (989803139301 only)	There are no periodic maintenance or calibration requirements that are necessary for continued airworthiness of the 989803139301 battery. For battery maintenance with respect to performance within the AED, please see Chapter 5. There are no user-serviceable parts in the battery.
environmental qualification per RTCA/DO-227, Section 2.3	Meets following acceptance criteria: No leaking, venting, distortion, fire, or rupture. Change in open circuit voltage <2%.

Infant/Child Key 989803139311

category	specifications
size	6.3" x 2.4" x 0.2" (16 cm x 6 cm x 0.5 cm).
weight	1.0 oz (29 g).
material	Polycarbonate.

* The conditions and tests required for TSO approval of this article are minimum performance standards. It is the responsibility of those installing this article either on or within a specific type or class of aircraft to determine that the aircraft installation conditions are within the TSO standards. TSO articles must have a separate approval for installation in an aircraft. The article may be installed only if performed under 14 CFR Part 43 or the applicable airworthiness requirements.

Environmental considerations

By complying with your national or local regulations regarding disposal of electric, electronic, and battery waste, you can make a positive contribution to our shared environment.

product	information
defibrillator	The defibrillator contains electronic components. Do not dispose of it as unsorted municipal waste. Collect such electronic waste separately and dispose of it at an appropriate recycling facility according to your country's or local regulations.
battery	The battery cells contain chemicals. The chemistry used in each battery is identified by a symbol on the label; symbols are defined in the defibrillator User's Guide/Instructions for Use/Owner's Manual. Recycle the battery at an appropriate recycling facility.
pads	The used pads may be contaminated with body tissue, fluid, or blood. Dispose of them as infectious waste. Recycle the case at an appropriate recycling facility.

F Configuration

Overview

The Philips HeartStart FRx Defibrillator comes with a factory default configuration designed to meet the needs of most users. This configuration can only be changed by using HeartStart Configure version 1.0 or higher, Event Review version 3.2 or higher, or Event Review Pro 3.1 or higher. This software is for use by trained personnel. Information about HeartStart data management products is available online www.medical.philips.com/goto/eventreview. See Appendix A for ordering information.

Device options

The following table includes the features of FRx operation that are not related to patient treatment

parameter	settings	default	default description
speaker volume	1, 2, 3, 4, 5, 6, 7, 8	8	The volume of the FRx's speaker is set to 8, highest.
auto send periodic self-test (PST) data	On, Off	On	Enables the periodic self-test data to be broadcast through the device's infrared data port.
ECG out data	On, Off	On	Enables the ECG data to be broadcast through the device's infrared data port.

Patient treatment protocol options

parameter	settings	default	default description
“call EMS” voice reminder timing	<ul style="list-style-type: none"> • At power on (when the user turns on the FRx) • At power on and at the start of the first patient care pause • At the start of the first patient care pause • No reminder 	At the start of the first patient care pause.	Provides a voice reminder to make sure emergency medical services have been called, at the start of the first patient care pause.
shock series	1, 2, 3, 4	1	<p>The automatic protocol pause for CPR is activated each time a shock is delivered.*</p> <p>During the protocol pause, the FRx does not perform rhythm analysis.</p> <p>The length of the protocol pause after a shock series is completed is determined by the protocol pause timer setting.</p>
shock series interval (minutes)	1.0, 2.0, ∞ (infinity)	1.0	<p>A delivered shock must occur within 1 minute of the previous shock to be counted as part of the current shock series.</p> <p><i>NOTE: This parameter is only applicable when the shock series is not configured to the default 1 shock.</i></p>

* A shock series begins when a shock is delivered after the FRx is turned on. A new shock series begins after a protocol pause. If shock series is configured for 2 or more, a new shock series also begins if the time since the previous shock exceeds the shock series interval setting.

parameter	settings	default	default description
protocol pause timer (minutes)	0.5, 1.0, 1.5, 2.0, 2.5, 3.0	2.0	<p>A 2-minute protocol pause for CPR automatically starts after voice instruction is given when a shock series is completed. After the protocol pause, the defibrillator returns to rhythm analysis.</p> <p>If the user presses the i-button for optional CPR coaching, the FRx provides coaching for 5 cycles of CPR, starting and ending with compressions, when the CPR Coaching parameters are also set to their default values. The number of CPR cycles varies for other protocol pause timer and CPR Coaching parameter settings.</p>
NSA pause type	<ul style="list-style-type: none"> Standard NSA pause: FRx does not perform rhythm analysis during the NSA pause. SMART NSA pause: FRx conducts background monitoring during the SMART NSA pause. If a potentially shockable rhythm is detected, FRx terminates the SMART NSA pause and resumes rhythm analysis. 	SMART NSA pause	<p>During a SMART NSA pause, the defibrillator conducts background monitoring. If a potentially shockable rhythm is detected in a motionless patient, the defibrillator terminates the SMART NSA pause and resumes rhythm analysis.</p> <p><i>NOTE: If the FRx detects CPR in progress or if the responder has pressed the i-button for CPR Coaching, the SMART NSA pause will be converted to a standard NSA pause. During the standard NSA pause, the defibrillator does not perform rhythm analysis.</i></p>

parameter	settings	default	default description
NSA pause timer (minutes)	0.5, 1.0, 1.5, 2.0, 2.5, 3.0	2.0	A 2-minute NSA pause for CPR automatically starts after voice instruction is given when no shock is advised (NSA).* If the user presses the i-button for optional CPR coaching, the FRx provides coaching for 5 cycles of CPR, starting and ending with compressions, when the CPR Coaching parameters are also set to their default values. The number of CPR cycles varies for other NSA pause timer and CPR Coaching parameter settings.
CPR prompt	<ul style="list-style-type: none"> • CPR1: Instructs the user to begin CPR. • CPR2: Instructs the user that it is safe to touch the patient and to begin CPR. • CPR3: Instructs the user to begin CPR and to press the i-button for CPR Coaching. • CPR4: Instructs the user that it is safe to touch the patient, to begin CPR, and to press the i-button for CPR Coaching. 	CPR4: Instructs the user that it is safe to touch the patient, to begin CPR, and to press the i-button for CPR Coaching.	The CPR reminder voice instructions provided at the beginning of a pause interval assures the user that it is safe to touch the patient, instructs the user to begin CPR, and invites the user to press the i-button for guidance in the basic steps of CPR. <i>NOTE: CPR Coaching is available only with the CPR3 and CPR4 settings.</i>

* If the shock series is configured to 2 or more, and a shock has been delivered as part of a series, the length of the first NSA pause interval within that shock series is determined by the protocol pause timer setting. Otherwise, the length of an NSA pause is determined by the NSA pause timer setting.

parameter	settings	default	default description
CPR Coaching adult ventilation instruction	yes, no	yes	Optional CPR Coaching includes rescue breaths at the rate determined by the CPR Coaching compression:ventilation ratio for adults when an adult pads set is installed. <i>Note: if this parameter is configured to NO, CPR Coaching will always be compressions-only when an adult pads set is installed.</i>
CPR Coaching infant/child ventilation instruction	yes, no	yes	Optional CPR Coaching includes rescue breaths at the rate determined by the CPR Coaching compression:ventilation ratio for infants and children when an infant/child pads set is installed. <i>Note: if this parameter is configured to NO, CPR Coaching will always be compressions-only when an infant/child pads set is installed.</i>
CPR Coaching compression:ventilation ratio	<ul style="list-style-type: none"> • 30:2 adult and 30:2 infant/child • 30:2 adult and 15:2 infant/child • 15:2 adult and 15:2 infant/child 	30:2 adult and 30:2 infant/child	When the user presses the i-button for optional CPR Coaching during a protocol pause or NSA pause, the FRx will provide coaching in basic CPR for cycles of 30 compressions and 2 ventilations for adults, children, and infants. Pauses begin and end with compressions.

G Testing and troubleshooting

Testing

The HeartStart FRx Defibrillator automatically tests its battery, connected SMART Pads II, and internal circuitry every day. It alerts you if it finds a problem. See the Technical Reference Guide, available online at www.medical.philips.com/heartstart, for a detailed discussion of the self-tests.

You can also test the defibrillator at any time by removing the battery for five seconds then reinstalling it. This test takes about one minute. Because the battery insertion self-test is very detailed and uses battery power, running it more often than necessary will drain the battery prematurely. It is recommended that you run the battery insertion self-test only:

- when the defibrillator is first put into service.
- after each time the defibrillator is used to treat a patient.
- when the battery is replaced.
- when the defibrillator may have been damaged.

Note: If the FRx turns off when you install the battery instead of running the battery insertion self-test, check to be sure that the pads case is not open. If the pads case is open, the FRx assumes that it may be in use and so will not run the self-test.

If you need to use the defibrillator to treat a victim of SCA while you are running a battery self-test, press the On/Off button to stop the test and turn on the HeartStart FRx for use.

Troubleshooting

The FRx's green Ready light is the signal that tells you if the defibrillator is ready for use. The defibrillator chirps and the i-button flashes to alert you to a problem.

Recommended action when you need to use the device

If the FRx is chirping and the blue i-button is flashing, it is possible that the defibrillator still has enough battery power to be used to treat a victim of SCA. Press the On/Off button.

If the FRx does not turn on when you press the On/Off button, remove the battery and replace it with a new battery if available and press the On/Off button to turn on the defibrillator. If no spare battery is available, remove the installed battery for five seconds, then reinsert it and run a battery insertion self-test.

If the problem continues, do not use the defibrillator. Attend to the patient, providing CPR if needed, until emergency medical personnel arrive.

Troubleshooting while the FRx is being used (green Ready light is solid)

Always follow any instructions the device gives.

defibrillator says:	possible cause	recommended action
... to replace the battery immediately	The battery is nearly depleted. The FRx will turn off unless a new battery is installed.	Install a new battery immediately.
... to plug in pads connector ... to replace pads	<ul style="list-style-type: none"> The pads connector has been unplugged. The pads have been damaged. The pads have been peeled from the case, but have not been successfully attached to the patient. There may be a problem with the pads. 	<ul style="list-style-type: none"> Plug in the pads connector. Replace the damaged pads. Replace the pads on patient with new pads to continue with the rescue.
... to press the pads firmly to the skin ... to make sure the pads have been removed from the case ... the pads should not be touching the patient's clothing ... to make sure the pads connector is fully inserted	<ul style="list-style-type: none"> The pads are not properly applied to the patient. The pads are not making good contact with the patient's bare chest because of moisture or excessive hair. The pads are touching each other. The pads may not have been removed from the case or may be on the patient's clothing. Pads connector is not fully inserted. 	<ul style="list-style-type: none"> Make sure that the pads are sticking completely to the patient's skin. If the pads are not sticking, dry the patient's chest and shave or clip any excessive chest hair. Reposition the pads. Make sure pads are not in the case or on patient's clothing. Make sure the pads connector is fully inserted. <p>If the voice instruction continues after you do these things, replace the pads set.</p>

defibrillator says:	possible cause	recommended action
... to stop all motion	<ul style="list-style-type: none"> • The patient is being moved or jostled. • The environment is dry and movement around the patient is causing static electricity to interfere with ECG analysis. • Radio or electrical sources are interfering with ECG analysis. 	<ul style="list-style-type: none"> • Stop CPR; do not touch the patient. Minimize patient motion. If the patient is being transported, stop the vehicle. • Responders and bystanders should minimize motion, particularly in dry environments that can generate static electricity. • Check for possible causes of radio and electrical interference and turn them off or remove them from the area.
... the shock was not delivered	<ul style="list-style-type: none"> • The pads may not be making good contact with the patient's skin. • The pads may be touching each other. • The pads may be damaged. 	<ul style="list-style-type: none"> • Press the pads firmly to the patient's chest. • Make sure the adhesive pads are correctly positioned on the patient. • Replace the pads if necessary.
... the shock button was not pressed	Shock has been advised but the shock button has not been pressed within 30 seconds.	When next prompted, press the Shock button to deliver shock.

Troubleshooting while the FRx is not being used
(green Ready light is *not* on)

Press the blue i-button to check defibrillator status, and follow any instructions the device gives.

behavior	possible cause	recommended action
chirps or i-button flashes	<ul style="list-style-type: none"> • The battery power is low or the pads need to be replaced. • The pads may be damaged or the adhesive dried out. • The pads case may be open. • The defibrillator may have been turned off without a pads set installed. • The Training Pads II set has been left in the defibrillator. • The Infant/Child Key may have been left installed. • The defibrillator has been stored outside the recommended temperature range. • The defibrillator has detected an error during a self-test or cannot perform a self-test, or the Shock button is damaged. 	<ul style="list-style-type: none"> • Press the blue i-button. Replace the battery or pads if instructed. • Replace the pads with a new set and do not open the case until pads are needed in an emergency. • Make sure the pads case is closed. • Make sure the pads are properly installed. (See Chapter 2 for directions.) • Remove the Training Pads II set and replace it with a set of SMART Pads II. • Remove the Infant/Child Key. • Remove the battery for five seconds then reinstall it to start the battery insertion self-test. If it fails, insert a new battery to repeat the test. If it fails again, do not use the defibrillator. If it passes, store the defibrillator within the recommended temperature range. • Contact Philips for service if needed.
no chirping and/or i-button does not flash, or no response to pressing i-button	<ul style="list-style-type: none"> • The battery is missing or completely depleted. • The defibrillator may have been physically damaged. 	<ul style="list-style-type: none"> • Remove the battery for five seconds then reinstall it to start the battery insertion self-test. If it fails, insert a new battery and repeat the test. If it fails again, do not use the defibrillator. • Contact Philips for service.

H Additional technical data required for European conformity

Electromagnetic conformity

Guidance and manufacturer's declaration: The HeartStart FRx is intended for use in the electromagnetic environment specified in the tables below. The customer or user of the HeartStart FRx should assure that it is used in such an environment.

Electromagnetic emissions

emissions test	compliance	electromagnetic environment – guidance
RF CISPR 11	Group I Class B	<p>The FRx uses RF energy only for its internal function. Therefore, its RF emissions are very low and are not likely to cause any interference in nearby electronic equipment.</p> <p>The FRx is suitable for use in all establishments, including domestic establishments and those directly connected to the public low-voltage power supply network that supplies buildings used for domestic purposes.</p>

Electromagnetic immunity

immunity test	IEC 60601 test level	compliance level	electromagnetic environment - guidance
electrostatic discharge (ESD) IEC 61000-4-2	± 6 kV contact ± 8 kV air	± 6 kV contact ± 8 kV air	There are no special requirements with respect to electrostatic discharge. ^a
power frequency (50/60 Hz) magnetic field IEC 61000-4-8	3 A/m	3 A/m	Power frequency magnetic fields should be at levels characteristic of a typical location in a typical commercial/hospital environment. There are no special requirements for non-commercial/non-hospital environments.
radiated RF IEC 61000-4-3	10 V/m 80 MHz to 2.5 GHz	[E1] V/m	Portable and mobile RF communications equipment should be used no closer to any part of the HeartStart FRx, including cables, than is absolutely necessary. ^{b,c} The recommended separation distances for various transmitters and the AED are shown in the following table. Interference may occur in the vicinity of equipment marked with the following symbol: 

NOTE 1. At 80 MHz and 800 MHz, the higher frequency range applies.

NOTE 2. These guidelines may not apply in all situations. Electromagnetic propagation is affected by absorption and reflection from structures, objects and people.

- Generally, AEDs are sometimes susceptible to interference generated by patient and/or responder motion in environments in which a high static electric field is present (e.g., low humidity, synthetic carpets, etc.). As a safety measure, Philips AEDs incorporate a patented method to sense possible corruption of the ECG signal by such interference and to respond by directing the user to stop all motion. In these cases, it is important to minimize movement in the vicinity of the patient during rhythm analysis in order to ensure that the signal being analyzed accurately reflects the patient's underlying heart rhythm.
- The ISM (industrial, scientific and medical) bands between 150 kHz and 80 MHz are 6,765 MHz to 6,795 MHz; 13,553 MHz to 13,567 MHz; 26,957 MHz to 27,283 MHz; and 40,66 MHz to 40,70 MHz.
- Field strengths from fixed transmitters, such as base stations for radio (cellular/cordless) telephones and land mobile radios, amateur radio, AM and FM radio broadcast, and TV broadcast cannot be predicted theoretically with accuracy. To assess the electromagnetic environment due to fixed RF transmitters, an electromagnetic site survey should be considered. If the measured field strength in the location in which the HeartStart FRx is used exceeds the applicable RF compliance level above, the HeartStart FRx should be observed to verify normal operation. If abnormal performance is observed, additional measures may be necessary, such as re-orienting or relocating the HeartStart.

Recommended separation distances between portable and mobile RF communications equipment and the HeartStart FRx Defibrillator

The HeartStart FRx Defibrillator is intended for use in an electromagnetic environment in which radiated RF disturbances are controlled. The customer or the user of the FRx can help prevent electromagnetic interference by maintaining a minimum distance between portable and mobile RF communications equipment (transmitters) and the FRx as recommended below, according to the maximum output power of the communications equipment.

rated maximum output power of transmitter (W)	separation distance according to frequency of transmitter (m)	
	80 MHz to 800 MHz $d = 0.6 \sqrt{P}$	800 MHz to 2.5 GHz $d = 1.15 \sqrt{P}$
0.01	0.06	0.115
0.1	0.19	0.36
1	0.6	1.15
10	1.9	3.64
100	6.0	11.5

For transmitters rated at a maximum output power not listed above, the recommended separation distance d in metres (m) can be determined using the equation applicable to the frequency of the transmitter, where P is the maximum output power rating of the transmitter in watts (W) according to the transmitter manufacturer.

NOTE 1. At 80 MHz and 800 MHz, the separation distance for the higher frequency range applies.

NOTE 2. The ISM (industrial, scientific and medical) bands between 150 kHz and 80 MHz are 6,765 MHz to 6,795 MHz; 13,553 MHz to 13,567 MHz; 26,957 MHz to 27,283 MHz; and 40,66 MHz to 40,70 MHz.

NOTE 3. An additional factor of 10/3 is used in calculating the recommended separation distance for transmitters in the ISM frequency bands between 150 kHz and 80 MHz and in the frequency range 80 MHz to 2.5 GHz to decrease the likelihood that mobile/portable communications equipment could cause interference if it is inadvertently brought into patient areas.

NOTE 4. These guidelines may not apply in all situations. Electromagnetic propagation is affected by absorption and reflection from structures, objects and people.

NOTE 5. Transmitters/antenna of this power-level are most likely mounted on an emergency vehicle chassis. The distances cited here are for open field. For an external antenna, the separation distance is most likely shorter.

Shock cycle timing

The FRx's Quick Shock feature allows it to deliver a shock within 8 seconds, typical, following a CPR pause. From shock to shock, the FRx takes <20 seconds, typical, including analysis. After 15 shocks, the FRx takes <30 seconds from analyzing to ready-to-shock. After 200 shocks, the FRx takes <40 seconds from initial power-on to ready-to-shock.

Notes

Intentionally blank.

PHILIPS

Philips Medical Systems is part of
Royal Philips Electronics

Philips Medical Systems

United States

Philips Medical Systems
2301 Fifth Avenue, Suite 200
Seattle, WA, USA 98121
(800) 263-3342

Canada

Philips Medical Systems
281 Hillmount Road
Markham, Ontario
L6C 2S3
(800) 291-6743

Europe, Middle East, and Africa

Philips Medizin Systeme Boeblingen GmbH
Cardiac and Monitoring Systems
Hewlett-Packard Strasse 2
71034 Boeblingen, Germany
+49 7031 463 2254

Latin America

Philips Medical Systems
1550 Sawgrass Corporate Parkway, Suite 300
Sunrise, FL 33323, USA
(954) 835-2660

Asia Pacific

Philips Electronics Hong Kong Ltd.
30th Floor, Hopewell Centre,
17, Kennedy Road, Wanchai,
Hong Kong
(852) 2821 5888

REF: 989803138731



012569-0008